

JVC



ENGLISH

ESPAÑOL

FRANÇAIS

HDD NAVIGATION/DVD RECEIVER

NAVEGACIÓN HDD/RECEPTOR DVD

SYSTÈME DE NAVIGATION À DISQUE DUR/RÉCEPTEUR DVD

KD-NXD505

NAVTEQ
ON BOARD

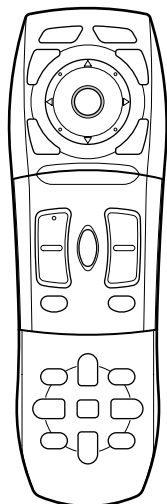

HDD



For installation and connections, refer to the separate manual.
Para la instalación y las conexiones, refiérase al manual separado.
Pour l'installation et les raccordements, se référer au manuel séparé.

For customer Use:

Enter below the Model No. and Serial No. which are located on the top or bottom of the cabinet. Retain this information for future reference.

Model No. _____

Serial No. _____

INSTRUCTIONS MANUAL DE INSTRUCCIONES MANUEL D'INSTRUCTIONS

LVT1774-001A
[J]

Thank you for purchasing a JVC product.

Please read all instructions carefully before operation, to ensure your complete understanding and to obtain the best possible performance from the unit.

IMPORTANT FOR LASER PRODUCTS

1. CLASS 1 LASER PRODUCT
2. **CAUTION:** Do not open the top cover. There are no user serviceable parts inside the unit; leave all servicing to qualified service personnel.
3. **CAUTION:**
(For U.S.A.) Visible and/or invisible class II laser radiation when open. Do not stare into beam.
(For Canada) Visible and/or invisible class 1M laser radiation when open. Do not view directly with optical instruments.
4. REPRODUCTION OF LABEL: CAUTION LABEL, PLACED OUTSIDE THE UNIT.

CAUTION	ATTENTION	AVISO	VARNING	注意	CAUTION
VISIBLE AND/OR INVISIBLE CLASS 1M LASER RADIATION WHEN OPEN, DO NOT VIEW DIRECTLY WITH OPTICAL INSTRUMENTS. EC99825-12001	RAYONNEMENT LASER VISIBLE ET/OU INVISIBLE DE CLASSE 1M UNE FOIS OUVERT. NE PAS REGARDER DIRECTEMENT AVEC DES INSTRUMENTS OPTIQUES. (ENG)	RADIACION LASER DE CLASE 1M VISIBLE Y/O INVISIBLE CUANDO ESTA ABIERTO. NO MIRAR DIRECTAMENTE CON INSTRUMENTAL OPTICO. (ESP)	SYNLIG OCH/ELLER OYNLIG LASERSTRÅLNING. KLASS 1M, NÄR DENNA DEL ÄR ÖPPNAD. BETRÄKTA EJ STRÅLEN MED OPTISKA INSTRUMENT. (SWE)	ここを開くと可視 及び/または不可視 のクラス1M レーザー放射が 出ます。 光学機器で直接 見ないでください。(JPN)	VISIBLE AND/OR INVISIBLE CLASS II LASER RADIATION WHEN OPEN. DO NOT STARE INTO BEAM. FMA 21 CFR (ENG) LV44808-003A

Warning:

If you need to operate the unit while driving, be sure to look ahead carefully or you may be involved in a traffic accident.

Caution:

Changes or modifications not approved by JVC could void the user's authority to operate the equipment.

Caution:

Never try to analyse or retrieve the data stored in the Hard Disk Drive (HDD). Otherwise, you may have your warranty invalid, and be penalized by law. The manufacturer assumes no liability for any damage resulting from such conduct as mentioned above.

Every time you turn on the unit, the screen below appears. Take enough care when operating the unit and make sure safe driving.

CAUTION!
**DRIVER IS RESPONSIBLE FOR
DRIVING DECISIONS AND
KEEPING EYES ON THE ROAD!**
Please see owner's manual
for complete safety
instructions. (ENT)

WARNINGS:

To prevent accidents and damage

- DO NOT install any unit in locations where:
 - it may obstruct the steering wheel and gearshift lever operations.
 - it may obstruct the operation of safety devices such as air bags.
 - it may obstruct visibility.
- DO NOT operate the unit while driving. If you need to operate the unit while driving, be sure to look ahead carefully.
- The driver must not watch the monitor while driving.
- If the parking brake is not engaged, “**Parking Brake**” flashes on the monitor, and no playback picture will be shown.
 - This warning appears only when the parking brake wire is connected to the parking brake system built in the car (refer to the Installation/Connection Manual).

This unit does not function properly unless the speed signal lead is connected (refer to the Installation/Connection Manual).

Hard Disk Drive (HDD)

Installation

This unit has a built-in HDD, which is a device to read minute magnetic changes. The inside of the device is precision components, requiring you to notice the following when installing the unit:

Install the unit at a place where the following conditions are satisfied:

- Dry and neither too hot nor too cold—between 5°C (41°F) and 35°C (95°F).
If the temperature is too low, the HDD will not work. Wait until the temperature in the car becomes normal before operating the unit.
- At an altitude between -300 m (-980 ft) below sea level and +3000 m (9800 ft) above sea level.
- With adequate ventilation to prevent internal heat buildup in the unit.

Before using HDD

While the unit is turned on, the hard disk is constantly rotating at a high speed. This requires you to notice the following:

- DO NOT impart vibration or shock.
- DO NOT allow anything having strong magnetism or emitting strong electromagnetic waves (cellular phones, etc.) near the unit.
- DO NOT disconnect the power cords from the car battery when the unit is turned on.

Failure in following the above cautions may damage the HDD (the stored data will be lost and be never restored).

When the temperature is low, the HDD may take some time to start up, or may reboot automatically.

It should be noted that it may be unlawful to re-record pre-recorded tapes, records, or discs without the consent of the owner of copyright in the sound or video recording, broadcast or cable programme and in any literary, dramatic, musical, or artistic work embodied therein.



How to reset your unit

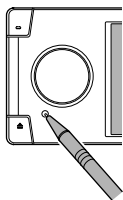

- Your preset adjustments will also be erased.

How to forcibly eject a disc

If a disc cannot be recognized by the unit or cannot be ejected, eject the disc as follows.

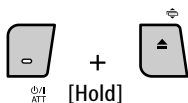

Emergency Eject and **No Eject** (or **Eject OK**) appear on the monitor.
 Press ▲ / ▼ repeatedly to select **Emergency Eject**, then press ENT.

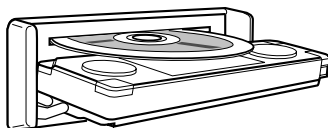

- If this does not work, reset your unit.
- Be careful not to drop the disc when it ejects.

How to detach/attach the control panel

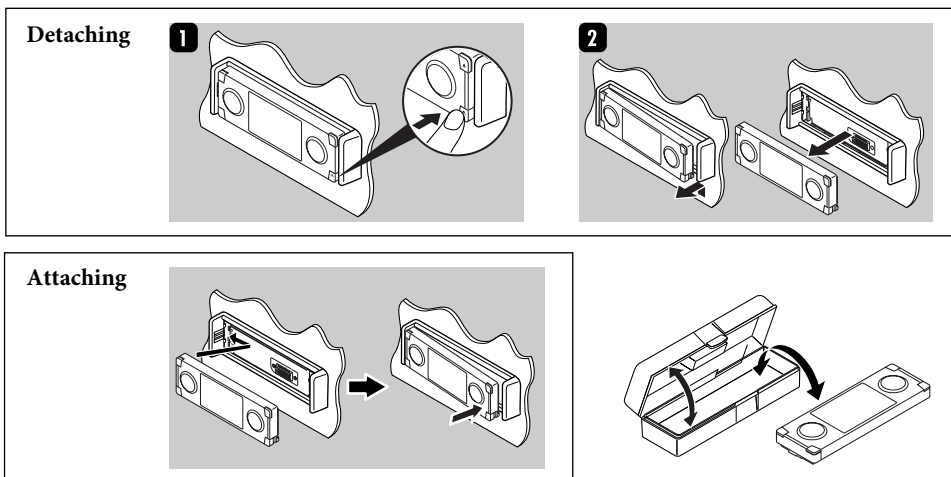

Cautions on the monitor:

- The monitor built in this unit has been produced with high precision, but it may have some ineffective dots. This is inevitable and is not malfunction.
- Do not expose the monitor to direct sunlight.

For safety...

- Do not raise the volume level too much, as this will block outside sounds, making driving dangerous.
- Stop the car before performing any complicated operations.

Temperature inside the car...

If you have parked the car for a long time in hot or cold weather, wait until the temperature in the car becomes normal before operating the unit.

Caution on volume setting:

Discs produce very little noise compared with other sources. Lower the volume before playing a disc to avoid damaging the speakers by the sudden increase of the output level.

This product incorporates copyright protection technology that is protected by U.S. patents and other intellectual property rights. Use of this copyright protection technology must be authorized by Macrovision, and is intended for home and other limited viewing uses only unless otherwise authorized by Macrovision. Reverse engineering or disassembly is prohibited.

INFORMATION (For U.S.A.)

This equipment has been tested and found to comply with the limits for a Class B digital device, pursuant to Part 15 of the FCC Rules. These limits are designed to provide reasonable protection against harmful interference in a residential installation. This equipment generates, uses, and can radiate radio frequency energy and, if not installed and used in accordance with the instructions, may cause harmful interference to radio communications. However, there is no guarantee that interference will not occur in a particular installation. If this equipment does cause harmful interference to radio or television reception, which can be determined by turning the equipment off and on, the user is encouraged to try to correct the interference by one or more of the following measures:

- Reorient or relocate the receiving antenna.
- Increase the separation between the equipment and receiver.
- Connect the equipment into an outlet on a circuit different from that to which the receiver is connected.
- Consult the dealer or an experienced radio/TV technician for help.



[European Union only]

Contents

8 Introduction

- Initial settings
- Basic operations
- Parts index
- Remote controller—RM-RK250

18 Navigation system



- Basic operations
- Registering your home
- Starting guidance
- Searching for a place
- How you are guided
- Arranging your route
- Registering favorite points
- Traffic information on map
- Navigation menu items

51 Radio



Listening to the radio
Listening to the satellite radio

59 Discs and HDD



Disc operations
Music server operations
CD changer operations

79 Other functions



iPod/D. player operations
Playing other external components
Using Bluetooth devices
AV Menu items
Sound equalization

109 Troubleshooting

117 Specifications

Initial settings

When you turn on the unit for the first time, the initial setup screen appears. Follow the procedure below and make necessary settings.

1 Turn on the power.

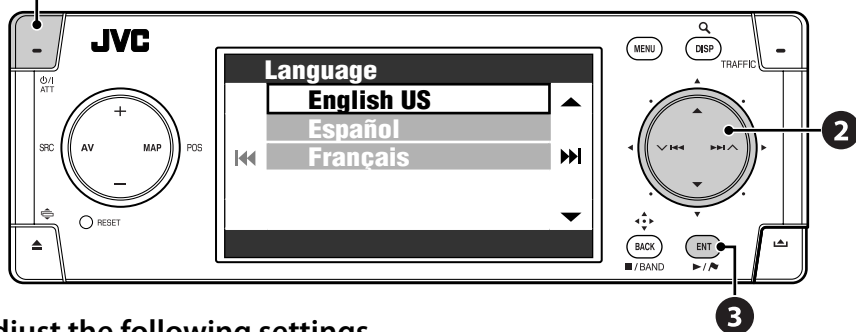

2 Adjust the following settings.

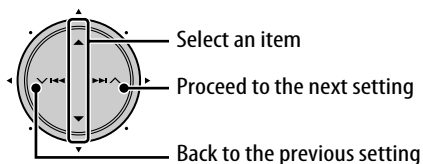

1 Language

Select the language you want for the display and the voice guidance.

2 Store Display Mode

Select **Off**.

- If you select **On**, the System starts in the navigation demonstration mode for shops. (☞ [47])

3 Installation Angle

Select which angle your unit is installed at. This setting is necessary for the precise functioning of the Navigation System.

- See “Measuring the installation angle” on the Installation/Connection Manual.

4 Time Zone

Select your residential area for clock adjustment.

5 DST

Select **Auto** if your residential area is subject to DST (Daylight Saving Time).

6 Reverse Polarization

Engage the parking brake, step on the brake pedal, then switch the gear lever. If **Forward** and **Reverse** alternates on the display, connection is correct. Select one of the alternatives (**GND** or **Battery**) that shows the gear position correctly.

3 Finish the procedure.



You can also change these settings (except **Store Display Mode**) through **Setup Menu** and **AV Menu** when necessary.

- **Language** ☞ [46]
- **Installation Angle** ☞ [46]
- **Time Zone** ☞ [91]
- **DST** ☞ [91]
- **Reverse Polarization** ☞ [94]

Calibration

Before using the Navigation System first time, it is required to calibrate the Navigation System.

- After deleting the calibration data (☰ [46] **Reset Calibration**) or changing the installation angle (☰ [46] **Installation Angle**), calibration is also required.

1 Display the map screen.



2 Display the detail screen and check the connections.

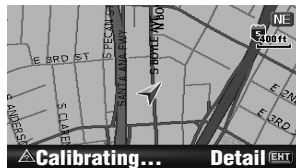

GPS Antenna

- **OK** ⇒ Connection is OK. ([5]: number of the GPS satellites whose signal is detected.)
- **NG** ⇒ Antenna is disconnected or short-circuited.

Speed Signal

Drive the car for a while.

- If the number increases as you speed up the car, connection is OK.

Parking Brake

Step on the brake pedal, then disengage and engage the parking brake repeatedly.

- If **Off** appears when disengaged and **On** appears when engaged, connection is OK.

Sensor Status	
Learning Lv.	:0
GPS Antenna	:OK [5]
Speed Signal	:12.0
Parking Brake	:Off
Direction	:Forward

Calibrating...



: Calibration not in progress.



: Calibration in progress.

If the result is not good, check the connection.

- You can see detailed information on the items of **Sensor Status** in **Information** ⇒ **Connection**. (☰ [43])

3 After confirming all the above connections, drive the car to start calibration.

- This process can take five minutes or more depending on the average speed driven.
- A certain speed (greater than 25 mi/h (40 km/h)) is required for calibration.
- Calibration time differs among the cars.
- During calibrating, you can use the AV functions of the unit (you can listen to the music, etc.)
- If you turn off the ignition switch, calibration is temporarily stopped. When it is turned on, calibration will restart.

Once calibration is finished, the arrowhead icon turns red and the current position information appears instead of **Calibrating...** **Learning Lv.** (maximum level is **4**) reaches **1** after calibration finished.

Navigation (functions such as guidance or route simulation) cannot be used until calibration is complete.

Basic operations

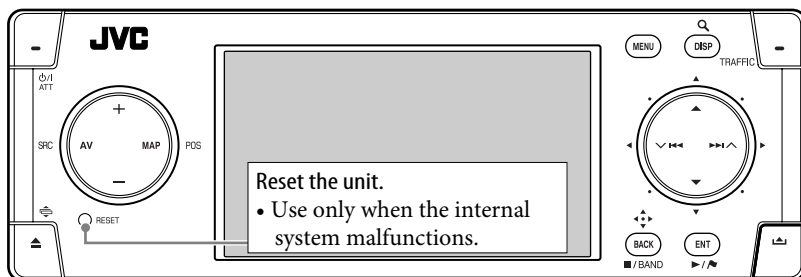

To turn on the power



φ/I
ATT

To turn off the power



[Hold]

φ/I
ATT

To drop the volume in a moment (ATT)



φ/I
ATT

ATT indicator flashes.

To restore the sound, press the same button again.

To adjust the volume



To change the source



SRC

AV

TUNER → SAT* → DISC* → HDD → CD-CH/
 EXT-IN/iPod/D. PLAYER* → Bluetooth Audio*
 → (Back to the beginning)

* You cannot select these sources if they are not ready.

To turn off the AV function



SRC

AV

[Hold]

The display switches to the map screen.

- To activate the AV function, press the button briefly.

For navigation operations, ☞ [18].

For radio operations, ☞ [51].

For disc/HDD operations, ☞ [59].

For Bluetooth operations, ☞ [83].

For other sources, ☞ [79].

To switch between the map screen and AV screen

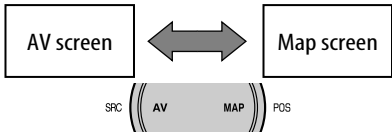

You can always switch between the AV screen and the map screen. This switching does not affect the playback sound of the unit (except while recording an Audio CD) or the guidance function of the Navigation System.

AV screen

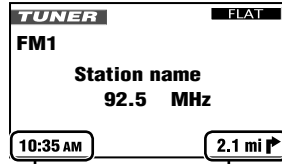

Distance to the next turn/Turn icon
(While not guided: Speed/Direction) (☞ [35])

Current time

The built-in clock is automatically adjusted by receiving the GPS signals.

To change the display of AV screens

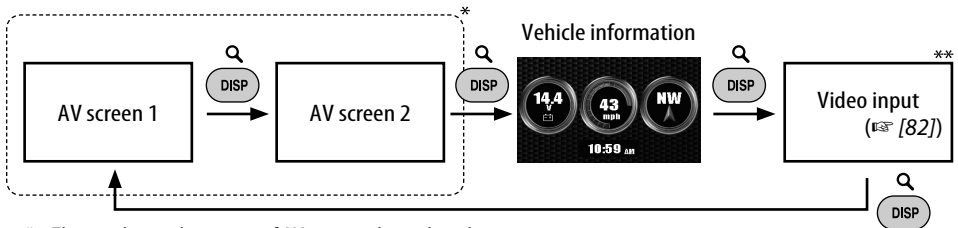

* The number and contents of AV screens depend on the source.

** Appears only when you have selected **Video** or **Camera** for **Video Input** setting (☞ [93]).

How to change the control panel angle

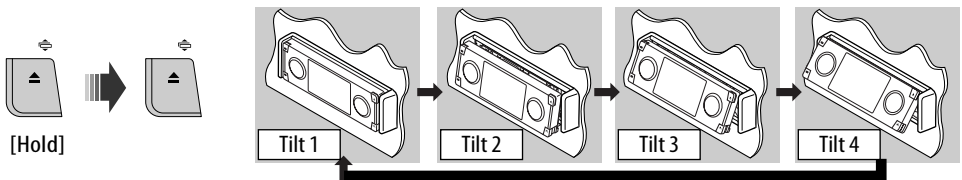

Caution: Do not insert your finger behind the control panel.

Menu operations

To call up a menu

Navigation Menus

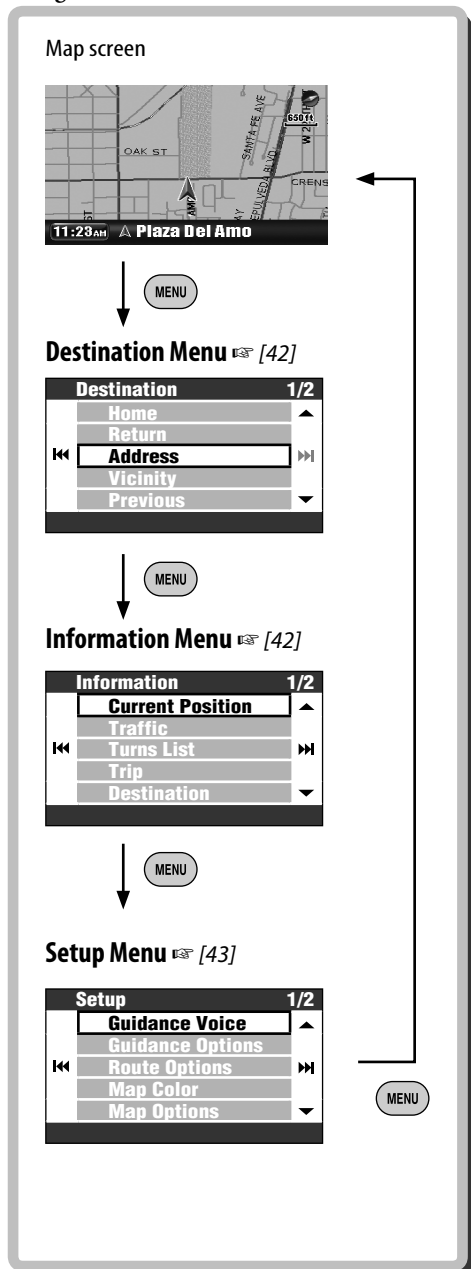

AV Menu

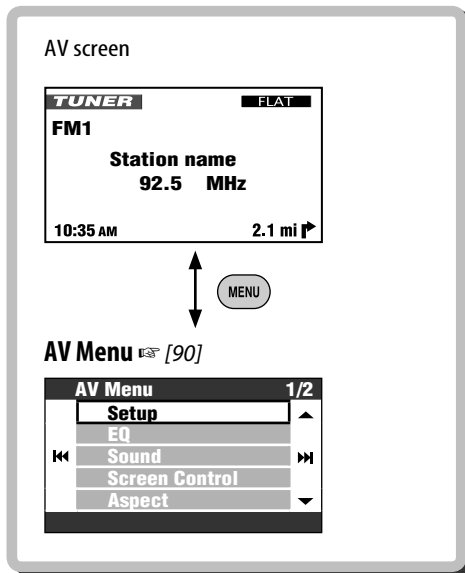

- The display indications may change according to change of the specifications.

To navigate through menus

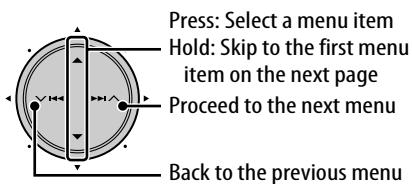

To go back to the previous screen and adjust other items:



To cancel menu operations and return to the map screen or the AV screen:



Menu screen

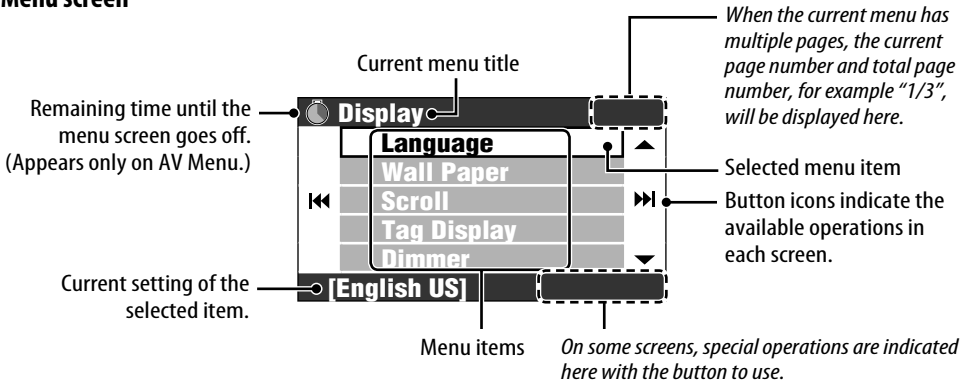

- If items are displayed in gray, you cannot use them now.

Ex.: **Delete ENT**

Ⓔ: Button to press

Ⓔ: Button to press and hold

- When no icon is displayed here, ENT button functions the same as ►►► button.

In this manual, operation of selecting a menu item is instructed as in the example below.

Ex.:

AV Menu

⇒ EQ

⇒ Pop

① Call up **AV Menu**.

② Select **EQ** in **AV Menu**.

③ Change the setting as you like.

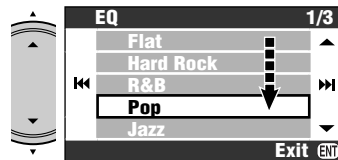
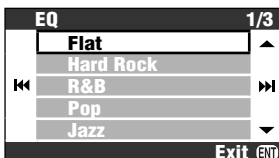
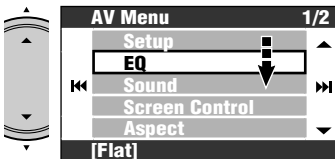

Now the setting is changed. Press DISP to exit from the menu, or BACK to go back to the previous menu.

Parts index

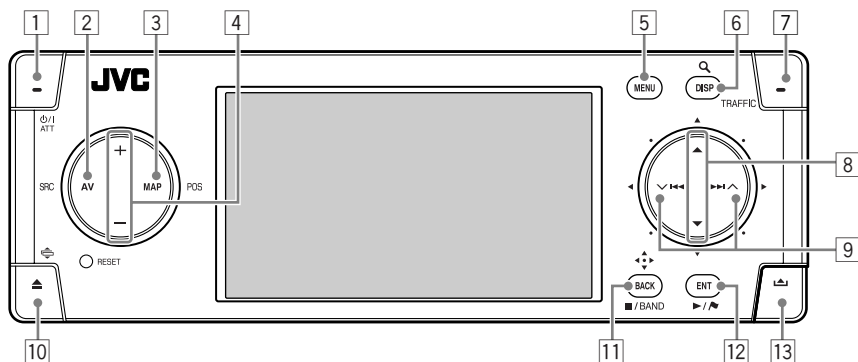

On the map screen

On the AV screens

On menu screens

1	φ/I/ATT	<ul style="list-style-type: none"> • Turn on the unit. • Turn off the unit if pressed and held. • Attenuate/restore the sound. 		
2	AV/SRC	Switch to the AV screen.	• Change the source.	In Navigation Menu: Switch to the AV screen. In AV Menu: Change the source and switch to the AV screen.
3	MAP/POS	<ul style="list-style-type: none"> • Change the map view. • Display your current position after scrolling the map. 	Switch to the map screen.	
4	+/-	Adjust the volume.		
5	MENU	Call up Destination Menu. [42]	Call up AV Menu. [90]	In Navigation Menu: Switch to other menus. In AV Menu: Go back to the top screen of AV Menu or switch to the AV screen.
		Call up Phone Menu if pressed and held when the Bluetooth adapter is connected. [83]		
6	Q/DISP	Enter the scaling mode.	Change the display. [11]	Exit from the menu.
7	TRAFFIC	Display the Traffic List. [40]	(Not used)	

	On the map screen	On the AV screens	On menu screens
8 ▲/▼	Operate the current source. [50]	FM/AM: Select preset stations. Satellite radio: Select categories. DVD: Select titles/groups. Files: Select folders. Music server: Select albums. iPod/D. player: ▲ Enter the main menu. ▼ Pause/resume playback. Bluetooth Audio: Select a device.	Select an item.
9 ▼/▶▶▶ /▶▶▶▲		FM/AM: Search for stations. Satellite radio: Search for channels. Disc, Music server, iPod/D. player, Bluetooth Audio: Select tracks/ chapters.	
10 ▲ ◀▶	<ul style="list-style-type: none"> • Open/close the control panel. • Change the control panel angle if pressed and held. 		
11 ◀▶/BACK ■/BAND	<ul style="list-style-type: none"> • Enter the manual scrolling mode. [22] • Repeat the last voice guidance if pressed and held during guidance. [33] 	Tuner: Select the bands. Disc: Stop playing.	Go back to the previous screen.
12 ENT/▶/▶	Call up Shortcut Menu. [25]	Disc: Start playing.	Confirm the selection.
13 ▲	Detach the control panel.		

Remote controller—RM-RK250

Installing the batteries

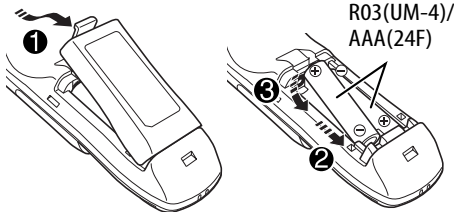

Before using the remote controller:

- Aim the remote controller directly at the remote sensor on the unit.

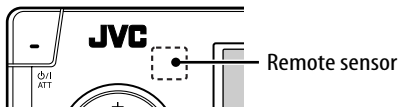













Caution:

- If the range or effectiveness of the remote control decreases, replace both batteries.
- Do not expose batteries to heat or flame.

The unit is equipped with the steering wheel remote control function.

- See the Installation/Connection Manual (separate volume) for connection.
- DO NOT expose the remote sensor to bright light (direct sunlight or artificial lighting).

Operations from the remote controller

	On the map screen	On the AV screens	On menu screens
1 AV/OFF	Switch to the AV screen.	• Change the source.	In Navigation Menus: Switch to the AV screen. In AV Menu: Change the source and switch to the AV screen.
	Turn off the AV function if pressed and held.		
2 MAP/POS	• Change the map view. • Display your current position after scrolling the map.	Switch to the map screen.	
3 MENU	Call up Destination Menu.  [42]	Call up AV Menu.  [90]	In Navigation Menus: Switch to other menus. In AV Menu: Go back to the top screen of AV Menu or switch to the AV screen.
	Call up Phone Menu if pressed and held when the Bluetooth adapter is connected.  [83]		
4 TRAFFIC	Display the Traffic List.  [40]	(Not used)	
5 ENT ►/	Call up Shortcut Menu.  [25]	Disc: Start playing/pause.	Confirm the selection.
6 ▲/▼	Scroll the map (in eight directions).	FM/AM: Select preset stations. Satellite radio: Select categories. DVD: Select titles/groups. Files: Select folders. Music server: Select albums. iPod/D. player: ▲ Enter the main menu. ▼ Pause/resume playback. Bluetooth Audio: Select a device.	Select an item.
7 ◀◀/▶▶ ∨/∧		FM/AM: Search for stations. Satellite radio: Search for channels. Disc, Music server, iPod/D. player, Bluetooth Audio: Select tracks/ chapters.	
8 PHONE 	Call up Dial Menu when the Bluetooth adapter is connected.  [86]		
9 BACK/BAND /  / 	Repeat the last voice guidance if pressed and held during guidance.	Tuner: Select the bands. Disc: Stop playing.	Go back to the previous screen.
10 VOL +/-	Adjust the volume.		
11 Q +/-	Scale the map.	(Not used)	
12 HOME	Start guidance to a home.  [24]	(Not used)	Start guidance to a home.  [24]
13 ATT	Attenuate/restore the sound.		
14 DISP	Enter the scaling mode.	Change the display.  [11]	Exit from the menu.



Only on the AV screens

15		<ul style="list-style-type: none"> • Make selections in disc menus. • DISC +/- buttons: Change discs for a CD changer.
16	ENT	Disc: Confirm the selection.
17	TOP M	DVD/DivX 6: Show the disc menu. [67]
18	DVD MENU	VCD with PBC: Resume PBC playback. [67]
19	OSD	Display the on-screen bar. [68]
20	RETURN	VCD with PBC: Return to the previous menu. [67]
21	DIRECT/ CLEAR	Disc: To select a chapter/title/group/folder/track directly. [66]
22	ASPECT	Disc: Change the aspect ratio of the playback pictures.
23	Number keys	Disc: To select a chapter/title/group/folder/track directly. [66] Tuner: Select a preset station. Satellite radio: Input a channel number directly or select a preset channel. CD changer: Select a disc. Bluetooth phone: Input telephone number. [87]
24		Disc: Reverse search/forward search. Slow playback if pressed while paused.
25		Disc: Select audio languages/audio channels.
26		Disc: Select subtitles.
27		Disc: Select a view angle.

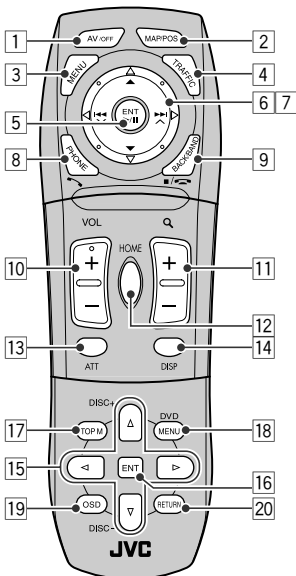

Slide to open

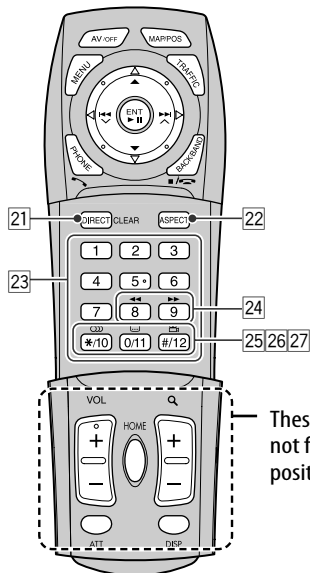

These buttons do not function at this position.

Navigation System

20	Safety instructions for Navigation System	
22	Basic operations	
24	Registering your home	
	To register your home	24
	To go home	24
26	Starting guidance	
	Setting a destination using Shortcut Menu	26
	Setting a destination using Destination Menu	27
	To go back to where you started	27
28	Searching for a place	
	By address	28
	POI near a place/route	29
	From last destinations	30
	From the list of POI	30
	From your favorites	31
	By telephone number	31
	By coordinates	31
32	How you are guided	
	Getting information on your route and places	34
	Customizing how you are guided	35



36	Arranging your route	
	Setting places to stop by	36
	Saving and loading routes	37
	Avoiding a congestion ahead	37
38	Registering favorite points	
	Marking your favorite points	38
	Editing your favorite points	38
40	Traffic information on map	
	What is TMC?	40
	Checking the traffic information	40
	How traffic information is reflected in navigation	41
42	Navigation menu items	
	Destination Menu	42
	Information Menu	42
	Setup Menu	43
47	Additional information	

Safety instructions for Navigation System

SAFETY INSTRUCTIONS

Use of the Navigation System is only permitted if the traffic conditions are suitable and you are absolutely sure that no risk, obstruction or inconvenience will be incurred to you, your passengers or other road users. The requirements of the Road Traffic Regulations must always be followed. **The destination must not be entered while driving the car.**

The Navigation System serves solely as an aid to navigation. It never releases the drivers from their duties to drive carefully and to make own judgement in road traffic. Inaccurate or incorrect instructions may happen to be given due to changing traffic conditions. The actual road signs and traffic regulations must therefore always be observed. In particular, the Navigation System cannot be used as an aid to orientation when visibility is poor.

This Navigation System must only be used for its intended purpose. The volume of the car radio/Navigation System must be adjusted so that external noise is still audible.

Navigation guidance is performed, based on the database, therefore, it may not be applicable to the current situation because of changes in traffic conditions (e.g. changes in tollroads, principal roads, one-way traffic, or other traffic regulations). In this case, observe the current traffic signs or regulations.

- Traffic signs should be observed carefully while driving using the Navigation System. Navigation System is only an aid. Driver must always decide whether or not to heed the information provided. **JVC does not accept liability for erroneous data provided by the Navigation System.**
- Traffic guidance is restricted to passenger vehicles only. Special driving recommendations and regulations for other vehicles (e.g. commercial vehicles) are not included.
- **Do not operate the unit while driving.**

Terms of licence

You are granted a non-exclusive licence to use the database for your personal purposes. The present licence does not authorise the granting of sublicenses.

Use of the data is only permitted in this specific JVC system. It is forbidden to extract or make further use of significant parts of the database content, or to duplicate, modify, adapt, translate, analyse, decompile or reverse-engineer any part thereof.

**WARNING:**

Road traffic regulations always take priority when a vehicle is being driven in traffic. Navigation System is only an aid. Errors may occur in individual data items/entries. At all times, the driver must decide whether or not to heed the information provided. JVC does not accept liability for erroneous data provided by the Navigation System.

© 2006 NAVTEQ All rights reserved.

When replacing/rotating the tires:

It is required to clear all the accumulated calibration data which is important for accurate navigation. To clear the data, perform **Reset Calibration** on page 46.

On map updating

If “Your map data is more than one year old and updates may be available.” appears on the monitor, visit <<http://www.jvc-exad.com>>. For details about updating your unit, visit <<http://www.jvc-exad.com>>.

Basic operations

Current position mode

—The map scrolls automatically so that your position is always at the center of the map.

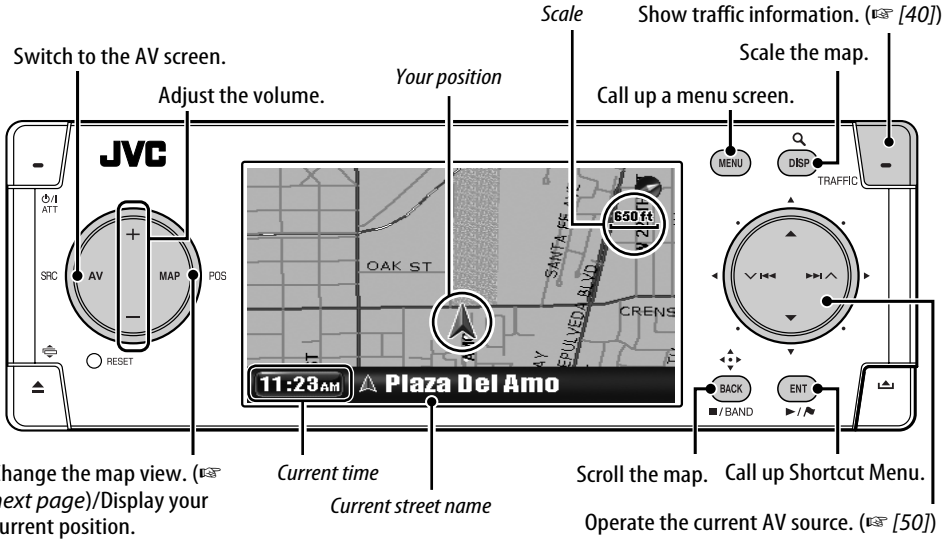

To scroll the map

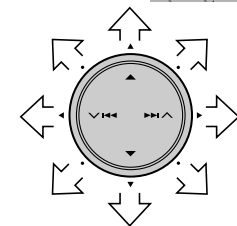

The map scrolls in eight directions.

- Press and hold the button to keep scrolling the map.

Direction and distance from your current position

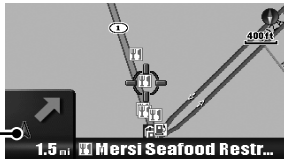

To change the map scale

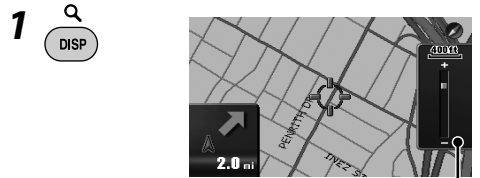

- Zoom in
- Zoom in rapidly
- Zoom out
- Zoom out rapidly

Scale bar

To display your current position



To change the map view



The map view changes as follows:
Heading Up → 3D Map → North Up



Heading Up

The map rotates so that you are always displayed heading “upwards.” The direction is displayed with a compass icon



3D Map

The map is displayed in “heading up” and in a three-dimensional view. The direction is displayed with a compass icon



North Up

The map view is oriented with north “upwards,” like usual paper maps. The direction you are heading to is displayed at the upper right corner of the screen with an icon such as NE.



You can also change the map view through **Setup Menu** ⇒ **Map Options** ⇒ **Map View** (☰ [45]).

To call up menus

Navigation Menus



Each time you press the button, the menu switches as follows:

- (Map screen)
- Destination Menu
- Information Menu
- Setup Menu
- (Back to the map screen)

Menu operations ☰ [13]

Menu items ☰ [42 – 46]

Shortcut Menu

While the map is displayed...



Shortcut Menu appears. ☰ [25]

Icons on the map

	Favorite points (☰ [38 – 39])
	POI (Point Of Interest) (☰ [30, 49])
	Traffic (☰ [40, 50])

- Favorite icons are displayed on the map when a group is selected in the **Favorite Icon** setting (☰ [45]) and the map scale is between 100 ft (30 m) and 1.2 mile (2.0 km).
- POI icons are displayed on the map when a group is selected in the **POI Icon** setting (☰ [45]) and the map scale is 100 ft (30 m) or 160 ft (50 m). (The airport icons are displayed when the map scale is between 100 ft (30 m) and 2.0 mi (3.0 km).)
- Traffic icons are displayed on the map when the **Traffic Display** setting is activated (☰ [45]) and the map scale is between 100 ft (30 m) and 1.2 mile (2.0 km).

Registering your home

To register your home

Register your home or your office, wherever you go often, as Home, so that you can easily set that place as destination.

- You can register homes only after calibration is finished. (☞ [9])

1 If you are at home now, check that your home is displayed at the center of the map.

- Adjust the position by scrolling the map if necessary.

2 Call up Shortcut Menu.



3 Select [Add to Favorite] .

The home is marked with  icon.

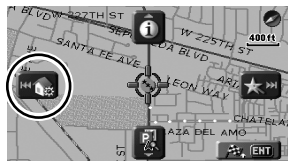

4 Select [Set Home] .



A confirmation message appears. Press ENT to confirm the operation. Press BACK to cancel.

The home is marked with  icon.

- The icon may not appear depending on the map scale and your **Favorite Icon** setting. (☞ [45])
- You can register several places as Home by registering the places as favorite points and setting their group to **Home**. (☞ [38, 39])

To go home (Home)

When you have registered your home, you can easily get guided to home.

While not guided...

1 Call up Shortcut Menu.



2 Select [Go Home] to start guidance.



- If you have registered several homes, select the one you want to go to from a list.

On the remote:

HOME



You can also be guided to home through **Destination Menu** ⇒ **Home**.

To cancel guidance

1 Call up Shortcut Menu.

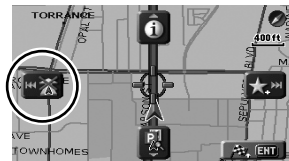

2 Select [Cancel Guidance] .



You can also cancel guidance through **Destination Menu** ⇒ **Cancel Guide**.

What is Shortcut Menu?

On the map screen, you can call up Shortcut Menu by pressing ENT. Shortcut Menu is a gateway to various operations.

Map screen

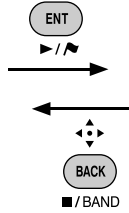

To select an icon, press ENT or one of the four keys on the right circle button corresponding to the icon.

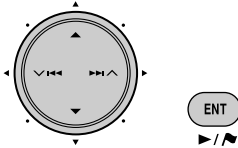

Shortcut Menu

While not guided

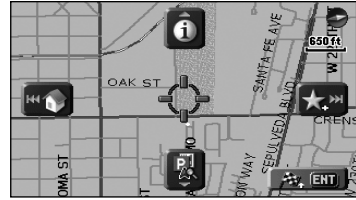

While guided

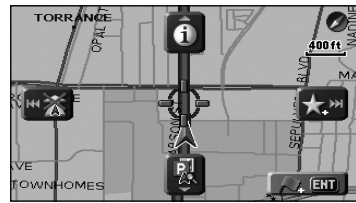

Icon	Name	Function	Button
	View Information	Show information on this place. [35]	
	Go Home	Start guidance to a home. [24] (Not selectable if no home is registered.)	
	Set Home	Register this place as home. [24] (Appears when no home is registered and a favorite icon is selected.)	
	Cancel Guidance	Cancel the guidance. [24]	
	Add to Favorite	Add this place to your favorite points. [38]	
	Edit Favorite	Edit this favorite point. [39] (Appears only when a favorite icon is selected. Not selectable while driving.)	
	Vicinity	Search for POI around this place. [29]	
	Go Here	Start guidance to this place. [26]	
	Add to Via Point	Recalculate the route to stop by this place. [36] (Appears only while guided.)	

Starting guidance

- You can set destinations only after calibration is finished. (☞ [9])

Setting a destination using Shortcut Menu

- 1 Scroll the map to display the destination at the center of the map.

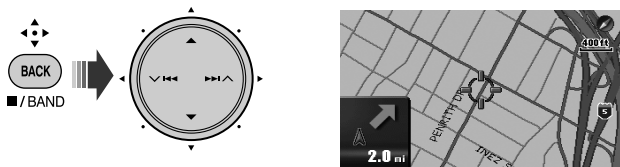

- 2 Call up Shortcut Menu.

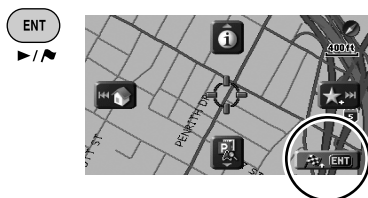

- 3 Select [Go Here]  [ENT] to start guidance.



The System starts calculating the route to the selected destination, and guidance starts.

To cancel guidance

- 1 Call up Shortcut Menu.



- 2 Select [Cancel Guidance] .



You can also cancel guidance through **Destination** Menu ⇨ **Cancel Guide**.

Setting a destination using Destination Menu

1 Call up Destination Menu.

MENU

2 Select one of the methods to search for your destination.

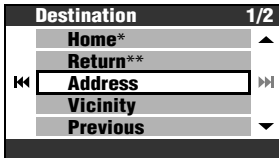

[24]
[below]
[28]
[29]
[30]

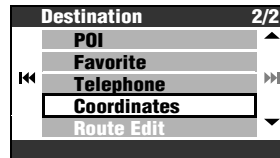

[30]
[31]
[31]
[31]

* During guidance, **Cancel Guide** appears.

** During guidance, **Avoid Section** appears.

- You cannot select the items when they are gray.

The information on the search result appears.



Direction and distance from your current position

To see the search result on map

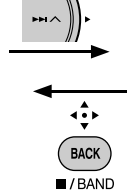
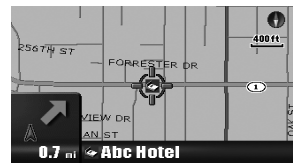

3 Select [Go Here] to start guidance.

ENT



The System starts calculating the route to the selected destination, and guidance starts.

To go back to where you started (**Return**)

You can go back to the start point of the last guidance.

1 Call up Destination Menu.

MENU

2 Destination

⇒ **Return**

Searching for a place

To input names, addresses, or numbers

Ex. Input screen for a city name

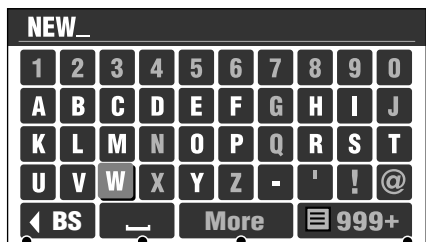

Enter a space Display other keyboards*
 Delete the last character Display the list of matches

* You can also change the keyboard by pressing DISP. For available characters, see [105].
 ** Buttons vary depending on the input item.

1 Enter characters.

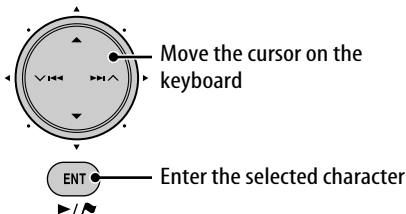

- Available characters are automatically narrowed down as the System searches its database for matches.

2 Display the list of matches.



- This button is available when the matches are narrowed down to 100 or less.
- You can also display the list of matches by pressing and holding ENT.
- When the matches are narrowed down to 5 or less, the list appears automatically.

3 Select the item you want from the list.

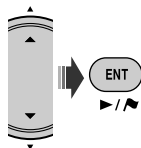

By address (Address)

1 Call up Destination Menu.



2 Destination

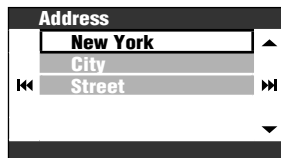

3 Input the state name.

- Input the city name if a state is already selected.



Displays the list of all the states.

4 Input the city name.



Select this to search by street name.

- Inputting characters [left column]

5 Input the street name.

- You can also select the center of the city. (The list of city centers may appear.) You do not have to input the house number in this case.
- Select the area to search from the list if **Select Area** is displayed.

6 Input the house number.

- You can also select the entire street or an intersection on the street.
- If no data of house number for the selected street is available in the database, this step is skipped.

POI near a place/route (Vicinity)

You can search for a POI around the place where you are now. While guided, you can also search for a POI near the destination or along the route.

1 Call up Destination Menu.



2 Destination ⇒ Vicinity

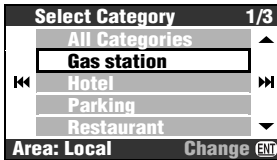

While guided, select the area to search if necessary.

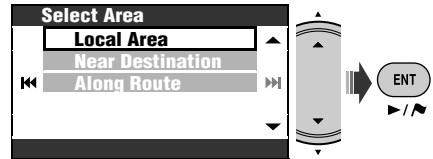

Local Area: within 1.2 mi (2 km) of your current position. If no POI is found in this area, the System expands the area to search.

Near Destination: within 1.2 mi (2 km) of the destination. If no POI is found in this area, the System expands the area to search.

Along Route: 30 mi (50 km) along the route you are taking.

3 Select a category (then a sub category if any) of the POI.

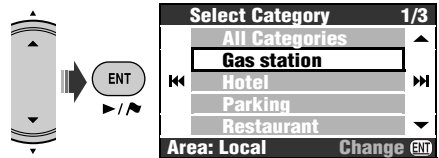

The result is listed in the order of distance from the place where you are.

4 Select a POI from the list.

You can search for a POI around a place on the map through Shortcut Menu ⇒

[Vicinity]  Follow steps **3** and **4** above after selecting **[Vicinity]**.

From last destinations (Previous)

You can select a place from the last 50 destinations and via points.

1 Call up Destination Menu.



2 Destination

⇒ Previous

The list of previous destinations/via points is displayed.

3 Select a place from the list.

To delete items in the list of previous destinations/via points

1 After step 2 above...



2 Check the boxes of the items you want to delete.

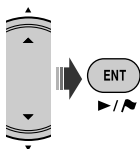

- Checkbox operations [105]

3 [Hold]

A confirmation message appears. Press ENT to confirm the operation. Press BACK to cancel.

From the list of POI (POI)

The System has a huge database of POI (Point Of Interest), such as restaurants, gas stations, hospitals, etc.

1 Call up Destination Menu.



2 Destination

⇒ POI

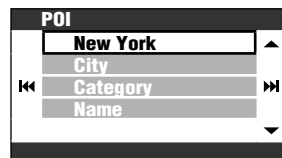

3 Input the state name.

- Input the city name if a state is already selected.

4 Input the city name.

- Inputting characters [28]

5 Select a method to search for a POI with.

You can search for a POI in two ways:

- a** By category and name
- b** Directly by name

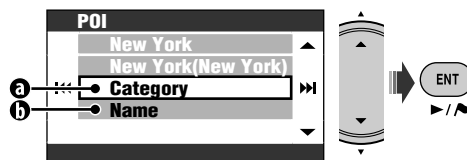

a By category and name

- 1 Select a category (then a sub category if any) of the POI.
- 2 Input the name of the POI you are looking for.
 - Inputting characters [28]
- 3 Select a POI from the list.

b Directly by name

- 1 Input the name of the POI you are looking for.
 - Inputting characters [28]
- 2 Select a POI from the list.

From your favorites (Favorite)

- Registering your favorite points [38].

1 Call up Destination Menu.



2 Destination ⇒ Favorite

Select Group		1/2
	Home	3
	Friend	12
⏪	Relative	6
	Business	26
	Visit	15
		Delete

3 Select a group.

4 Select a favorite point from the list.

By telephone number (Telephone)

1 Call up Destination Menu.



2 Destination ⇒ Telephone

3 Select a state.

- Input the telephone number if a state is already selected.

4 Input the telephone number.

Delete the last character

- Input Phone Number -		
1	2	3
4	5	6
7	8	9
⏪ BS	0	999+

Display the list of matches

- Inputting characters [28]

5 Select a POI from the list.

By coordinates (Coordinate)

1 Call up Destination Menu.



2 Destination ⇒ Coordinates

3 Input the latitude and the longitude.

Moves the cursor. To correct a misentry, move the cursor and enter the number again.

⊖ N 00° 00' 00" ⊕ W 000° 00' 00"		
1	2	3
4	5	6
7	8	9
⏪	0	⏩
South	Detail	

Switches South and North for latitude.

4 Select **Detail** when finished.

How you are guided

Destination found



Route calculation

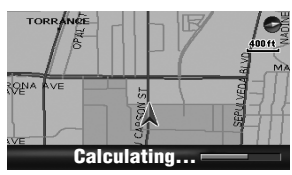

To cancel calculation, press BACK.

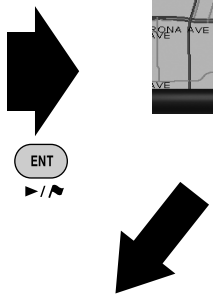

Screen while guided

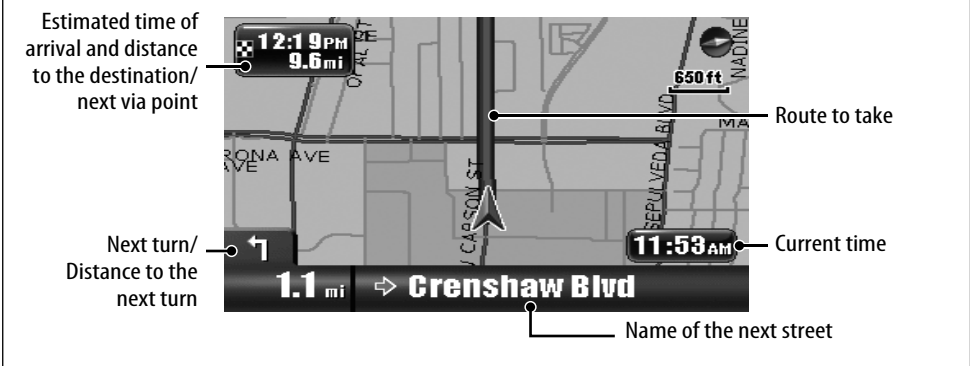

To cancel guidance

1 Call up Shortcut Menu.

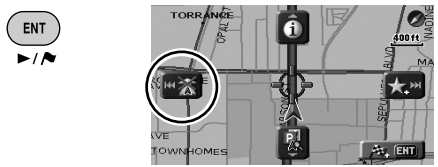

You can also cancel guidance through **Destination** Menu ⇒ **Cancel Guide**.

To adjust the volume of the voice guidance

[43] Volume

2 Select [Cancel Guidance]



Guidance at turns

When you approach a turn, the System guides you with voice guidance and indications on the screen.

- Guidance voice comes out only through the front speakers (and the front line out on the rear).

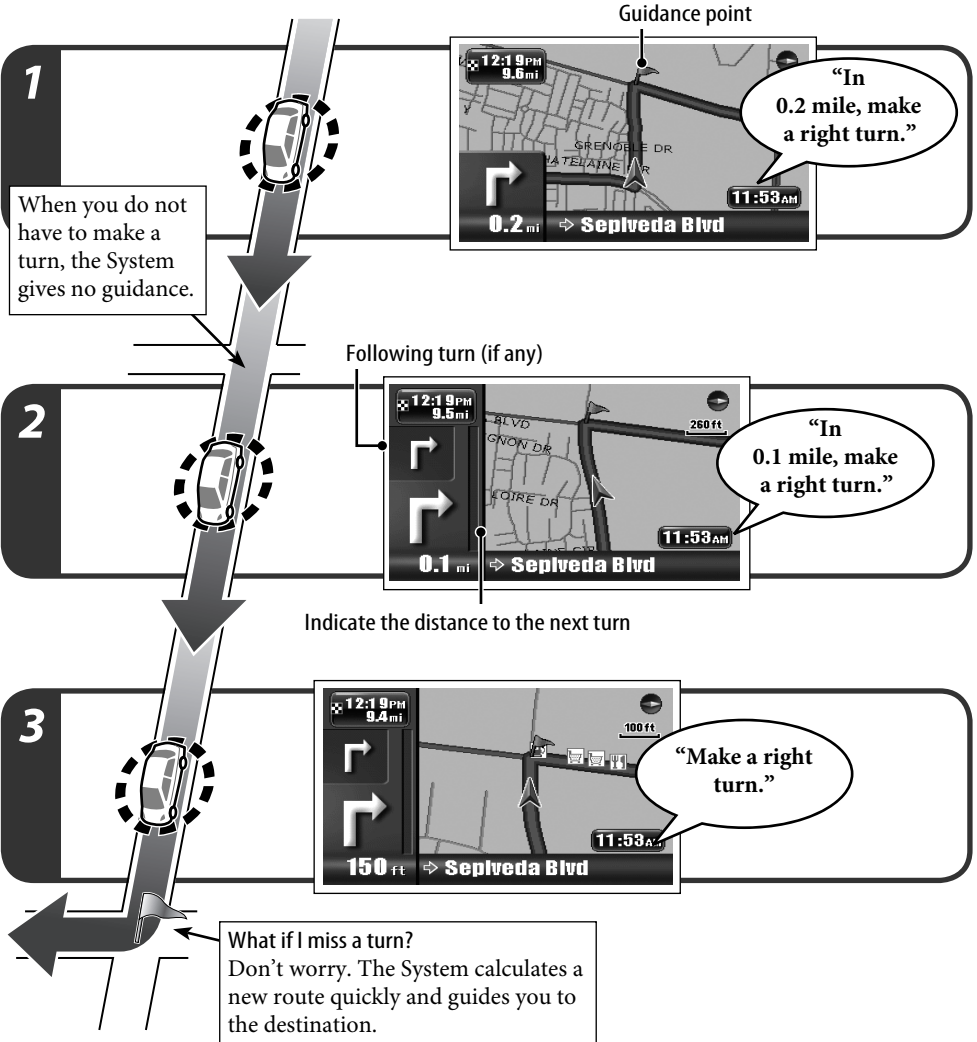

To repeat the last voice guidance



- You can remove the progress bar to the next turn by pressing MAP.

Getting information on your route and places

To see the itinerary and the turns list

- You can also view the trip through **Information** Menu ⇒ **Trip**.
- You can also view the turns list through **Information** Menu ⇒ **Turns List**.

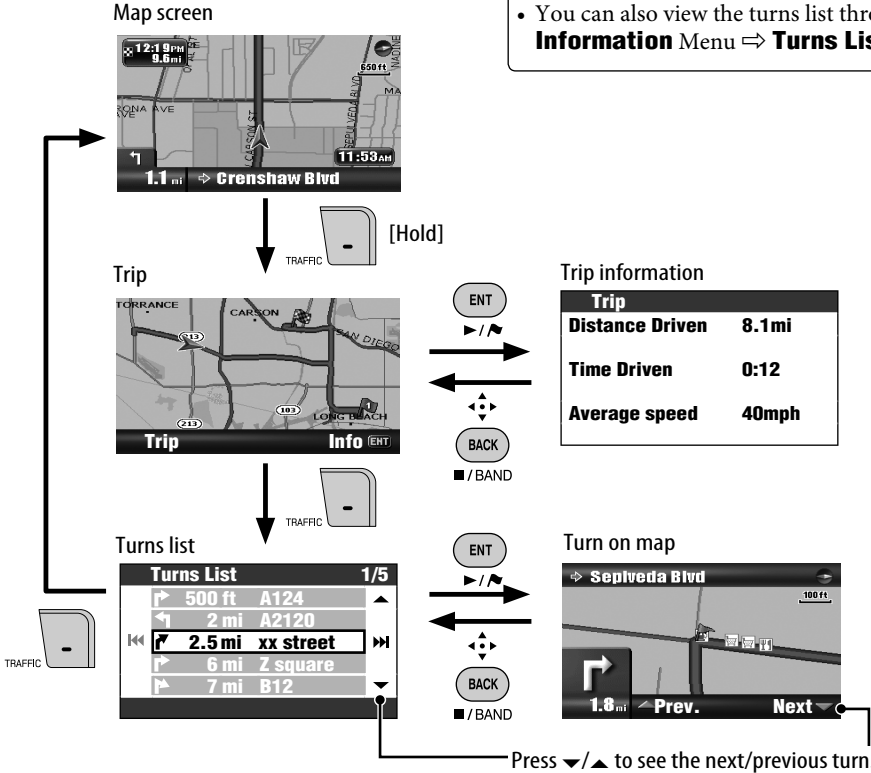

To get information on the destination and via points

1 Call up Information Menu.



2 Information ⇒ Destination

3 Select the destination or a via point.

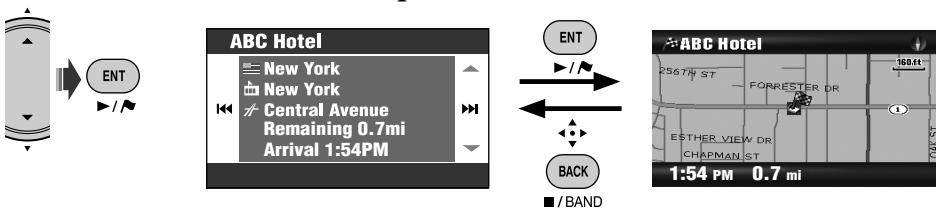

To check the estimated arrival time and distance to the next via point



Each time you press and hold the button, the information on the upper left corner alternates between that of the next via point and of the final destination.

To see information on a place

- This operation is always possible regardless of whether you are guided or not.

1 Display where you want to know of at the center of the map.

2 Call up Shortcut Menu.



3 Select [View Information]



If a telephone number is available, you can call to the number through JVC's Bluetooth adapter. [86]

You can also get information on your current position through **Information** Menu ⇨ **Current Position**.

To see how your trip will go

Information Menu ⇨ **Simulation**
DEMO appears on the display.

To cancel simulation and resume guidance, press MENU, then DISP.

DEMO disappears.

Customizing how you are guided

To customize the guidance and display on the map screen

[43] **Guidance View**

To customize how the map scale changes

[45] **Auto Zoom**

To customize the voice guidance on an AV screen

[44] **Interruption**

To customize the mixing of audio sound and voice guidance

[43] **Audio Mixing**

The guidance continues even when you switch the display to an AV screen. Guidance information is displayed on the lower-right corner of the AV screen.

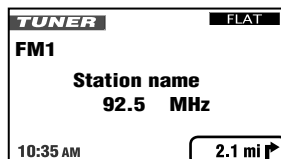

Distance to the next turn/Turn icon
(While not guided: Speed/Direction)

Arranging your route

Setting places to stop by

After selecting your destination, you can select up to nine places ("via points") to stop by.

To add via points

After guidance has started...

1 Select a place you want to stop by.

- Searching for a place [27]

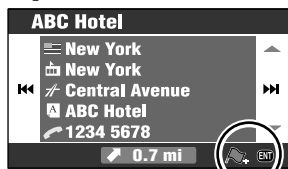

2 Select [Add to Via Point] .



The System starts calculating the new route, and guidance starts.

You can also set via points on the map through Shortcut Menu **[Add to Via Point]**.

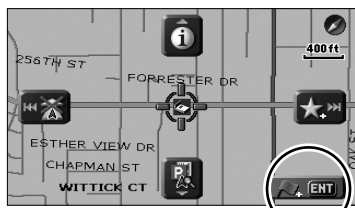

To rearrange the sequence of via points

1 Call up Destination Menu.



2 Destination ⇒ Route Edit ⇒ Edit

The list of via points appears.

3 Select the via point you want to move.

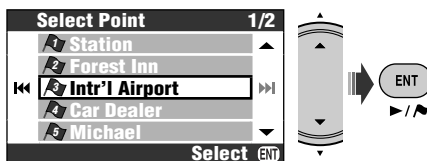

4 Move the selected via point in the list.

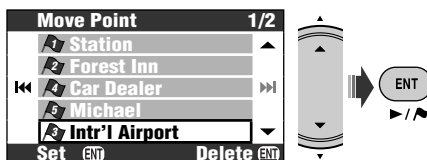

5 Repeat steps 3 and 4 to move other via points.

6 Finish the rearrangement.

- You can also use MENU, DISP, MAP, or .



■ / BAND

A confirmation message appears. Press ENT to confirm the operation. Press BACK to cancel.

The System starts calculating the new route, and guidance starts.

- No confirmation message appears if the via points are not changed.

To delete a via point

Press and hold ENT in step 4.

A confirmation message appears. Press ENT to confirm the operation. Press BACK to cancel.

For other options for routing [44] **Route Options**

Saving and loading routes

You can save up to 50 combinations of destination and via points. You can easily call up your usual route without the trouble of setting destinations.

- Each route can contain up to nine via points.

To save a route

1 Select your destination (and via points if necessary), and start guidance.

2 Call up Destination Menu.



3 Destination
⇒ Route Edit
⇒ Save

4 Name the route you are saving.

- Inputting characters [105]

5 Select **Store**.

To load a saved route

1 Call up Destination Menu.



2 Destination
⇒ Route Edit
⇒ Load

3 Select the route you want to take.

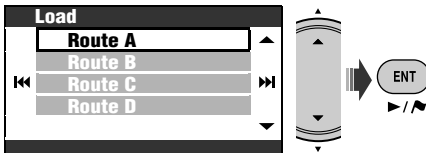

A confirmation message appears. Press ENT to confirm the operation. Press BACK to cancel.

The route is calculated, and guidance starts.

To delete saved routes

1 Call up Destination Menu.



2 Destination
⇒ Route Edit
⇒ Delete

3 Check the boxes at the head of the routes you want to delete.

- Checkbox operations [105]

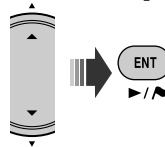

4 Delete the selected routes.



[Hold]

A confirmation message appears. Press ENT to confirm the operation. Press BACK to cancel.

Avoiding a congestion ahead

If you realize a congestion exists ahead...

While being guided...

1 Call up Destination Menu.



2 Destination
⇒ Avoid Section

3 Select the distance to avoid.

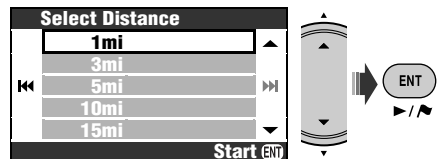

A confirmation message appears. Press ENT to confirm the operation. Press BACK to cancel.

A detour is calculated, and guidance starts.

Registering favorite points

Just like you mark your friend's house or a nice Chinese restaurant on your map book, you can register your favorite points in the system.

Marking your favorite points

- You can register 300 favorite points.
- You can register favorite points only when the map scale is 1.2 mile (2.0 km) or more detailed.

1 Display the place you want to save as favorite at the center of the map.

- Searching for a place [27]

2 Call up Shortcut Menu.



3 Select [Add to Favorite] .



The favorite point is registered in the group of **Other** and marked with icon.

- The icon may not appear depending on the map scale and your **Favorite Icon** setting. ([45])
- To be guided to a favorite point [31]

To proceed to edit the registered favorite point, select **[Edit Favorite]** after step **4**.



You can open the edit screen in step **3** of "Editing your favorite points."

Editing your favorite points

1 Call up Destination Menu.



2 Destination **Favorite**

Select Group		1/2
	Home	2
	Friend	12
◀	Relative	5 ▶
	Business	17
	Visit	24
Delete		

3 Select a group, then a favorite point to edit.

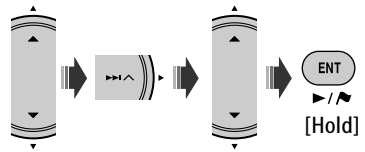

Edit Favorite	
	Input Name
	Other
◀	Input Address
	Input Phone Number
	Sound Off
Delete	

4 Select the item you want to edit.

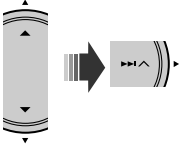

Name	The name of the favorite point. <ul style="list-style-type: none"> You can use up to 32 characters.
Group	See the table on the right for the available ten groups. Categorize the favorite points so that you can find them easily.
Address	The address of the favorite point.
Telephone number	If you have connected KS-BTA200, you can call to this number. [86]
Sound	Sound Off, Alarm, Bell, Siren You can assign a sound to each favorite point. You hear the assigned sound when you come close (about within 660 ft (200 m)) to the favorite point. <ul style="list-style-type: none"> Press ENT to listen to a sample sound.

5 Edit the item.

- Inputting characters [105]

Icons and groups for favorite points

	Home		Shopping
	Friend		Food
	Relative		Caution
	Business		Sightseeing
	Visit		Other

To delete a favorite point

Press and hold ENT after step 3 of “Editing your favorite points.”

A confirmation message appears. Press ENT to confirm the operation. Press BACK to cancel.

- You cannot delete a favorite point directly after editing it. To delete it, exit from the **Edit Favorite** screen once and do the procedure above.

To delete all the favorite points in a group

1 Press and hold ENT after step 2 of “Editing your favorite points.”

2 Select the groups to delete.

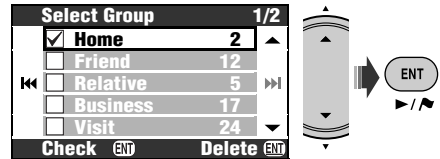

- Checkbox operations [105]

3 Delete the selected groups.



A confirmation message appears. Press ENT to confirm the operation. Press BACK to cancel.

Traffic information on map

What is TMC?

Traffic Message Channel (TMC) is a technology for delivering real-time traffic information to drivers. The traffic information sent by an FM radio station are received and analyzed by the System. The System can inform you of where congestion exists, and how you can detour it.

- You do not have to tune in to a special radio station to receive the traffic information.

How to get traffic information

Traffic information is supplied from NAVTEQ Traffic RDS.

As the traffic information is transmitted by FM radio stations, JVC cannot assume responsibility for the completeness or accuracy of the information.

Traffic information on the map

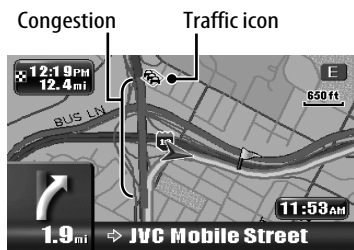

- List of traffic icons [50]
- Traffic icons and congestion lines are displayed on the map when the **Traffic Display** setting is activated ([45]).
- Traffic icons are displayed on the map when its scale is between 100 ft (30 m) and 1.2 mile (2.0 km).
- Congestion lines are displayed on the map when its scale is between 100 ft (30 m) and 3.0 mile (5.0 km).

Checking the traffic information

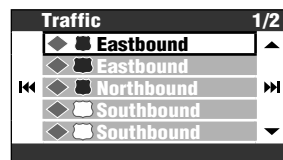

While guided, select the area to see the information of.

Along Route or All Information.

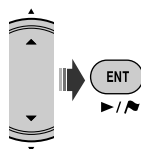

To see detailed information

Select an item on the list and press ►►.



You can also call up the Traffic List through **Information Menu** ⇒ **Traffic**.

You can also see detailed information of a traffic icon on the map in the following way: Display a traffic icon at the center of the map ⇒ Shortcut Menu ⇒ **[View Information]**

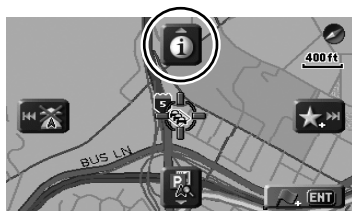

How traffic information is reflected in navigation

If **Bypass Traffic** is set to **Manual Reroute** (Ⓜ [44]), [Reroute] appears on the screen when the traffic service informs the System of traffic accidents or congestion ahead on your route.



To check the information and decide whether to calculate a detour



If **Bypass Traffic** is set to **Auto Reroute**, the System automatically calculates a new route when the traffic service informs of an obstacle on your route.

If **Bypass Traffic** is set to **Off**, the System does not take traffic information into account in calculating a route.

Navigation menu items

Destination Menu

Menu items	
Home	Start guidance to a home. (Appears only while not guided.) ☞ [24]
Cancel Guide	Cancels the guidance. (Appears only while guided.) ☞ [24, 26, 32]
Return	Starts guidance to the place where you have started your last guidance. (Appears only while not guided.) ☞ [27]
Avoid Section	Calculate a new route avoiding the selected distance ahead. (Appears only while guided.) ☞ [37] 1mi, 3mi, 5mi, 10mi, 15mi (or 1km, 3km, 5km, 10km, 15km)*1
Address	
Vicinity	
Previous	
POI	Search for a place using the database in the System. ☞ [27]
Favorite	
Telephone	
Coordinates	
Route Edit	<ul style="list-style-type: none"> • Arrange the order of via points. • Save, load or delete routes. ☞ [36] Edit, Save, Load, Delete

*1 Depends on your setting of **Measuring Units** (☞ [46]).

Information Menu

Menu items	
Current Position	You can see the information on your current position. State, City, Street, Latitude, Longitude
Traffic	You can check the traffic information. ☞ [40] Along Route *1, All Information
Turns List *1	You can see the list of turns on your route. ☞ [34]
Trip *1	You can see the information on your route. ☞ [34]
Destination *1	You can see the list of via points and the destination. ☞ [34]
GPS	You can see the status of GPS reception.

*1 Selectable only while guided.

Information Menu (continued)

Menu items	
Connection	You can check the connection status. Learning Lv., Angle, GPS Antenna, Gyro, Speed Signal, Parking Brake, Reverse Signal, Illumination, Tel. Muting
Version	You can check the model name, the version of the unit, and the version of the map database.
Simulation	Once the route is determined, you can simulate it on the map.  [35]

Setup Menu

	Menu items	Selectable settings	(Initial setting)
Guidance Voice	Gender	Female, Male ^{*1}	
	Volume	Adjust the volume of the voice guidance. ^{*1} Off, 01 to 50 (25)	
	Output Channel	Select the guidance output channel. ^{*1} L-ch Only, R-ch Only, L-ch & R-ch	
	Audio Mixing	You can turn down the volume of the AV source while voice guidance is produced. ^{*1} Muting: The AV source sound does not come out. Attenuation: The AV source sound is lowered. Normal: The AV source sound is not changed.	
Guidance Options	Guidance View	Select the items to be displayed at turns.	
		Auto Magnification:	<ul style="list-style-type: none"> • Next turn icon: Big • Following turn icon: On • Progress bar to the turn: On
		Symbolic View:	<ul style="list-style-type: none"> • Next turn icon: Big • Following turn icon: Off • Progress bar to the turn: Off
		Simple View:	<ul style="list-style-type: none"> • Next turn icon: Small • Following turn icon: Off • Progress bar to the turn: Off

*1 Press ENT to listen to a sample voice with the current setting.

Setup Menu (continued)

	Menu items	Selectable settings (Initial setting)
Guidance Options	Interruption	Select the voice guidance output on an AV screen. <ul style="list-style-type: none"> • A small icon of the next turn is always displayed at the lower-right corner of the AV screen while guided, regardless of this setting. If you want to see the turn on map, press MAP to switch to the map screen. Off, On
	Bypass Traffic	Off, Auto Reroute, Manual Reroute  [41]
	Voice Cruise	When this function is activated, the System automatically increases the guidance volume level as the car speeds up. To obtain stronger effect, set the level to higher numbers. Off, 01 to 10 (05)
	Attention Tone	Select the type of attention tone, which comes out before voice guidance. Off, Attention 1, Attention 2, Attention 3 <ul style="list-style-type: none"> • Press ENT to listen to a sample sound.
Route Options	Priority	Fastest: The System calculates the shortest journey time. Shortest: The System calculates the shortest route to the destination. <ul style="list-style-type: none"> • This setting is effective next time the System calculates a route.
	Avoid Highway	Check the boxes at the head of the options you want to be effective. <ul style="list-style-type: none"> • This setting is effective next time the System calculates a route.
	Avoid Ferry	
	Avoid Toll Road	
Map Color	Day Color	Select the color for the day screen. Type 1, Type 2, Type 3
	Route Color	Select the color for the route. Color 1, Color 2, Color 3
	Night Mode	Select the condition to switch the display to the night screen. Off: Cancels. Auto: Switches to the night screen when you turn on the headlights. Time: Switches to the day/night screen at set times. <ul style="list-style-type: none"> • When you choose Time, set when to switch the display color on the following screen.
	Brightness^{*2}	Set the brightness of the screen. -15 to +15 (00)

*2 This setting is shared with the **Screen Control** setting in AV Menu. ( [96])

Setup Menu (continued)

	Menu items	Selectable settings	(Initial setting)
Map Options	Map View	North Up, Heading Up, 3D Map  [23]	
	Auto Zoom	<p>Select how the zoom scale changes.</p> <p>Off: (Effective only while guided) Zoom into 100 ft (30 m) scale at turns if Guidance View is set to Auto Magnification. If else, the scale does not change at turns.</p> <p>Fit For Guidance: (Effective only while guided) When you approach turns, the scale changes gradually so that your current position and the turn is always displayed on the map at the same time.</p> <p>Fit For Speed: The scale changes gradually in accordance with the speed of your car; as you slow down, the map is zoomed in.</p>	
	POI Icon	Check the box at the head of each POI category to display its icons on the map.	
	Favorite Icon	Check the box at the head of each favorite group to display its icons on the map.	
	Car Tracks ^{*3}	<p>Display: Check the box to display the tracks of your car on the map.</p> <p>Record^{*4}: Check the box to record the track of your car.</p> <p>Delete: Deletes the recorded tracks.</p>	
	Street Name	Check the box to display the current/next street name on the monitor.	
	One-Way	Check the box to display the one-way icon on the map.	
	Traffic Display	Check the box to display the traffic icons on the map.	



^{*3} When you want the track of the current drive displayed, you need to check both **Display** and **Record**.

^{*4} The recorded tracks are deleted from old ones when the internal memory gets full.

Setup Menu (continued)

	Menu items	Selectable settings (Initial setting)
System Setting	Installation Angle	Select the angle of the unit measured by the supplied gauge. (See also the Installation/Connection Manual.) 1: -5.0° to 1.0° 2: 1.0° to 6.0° 3: 6.0° to 14.0° 4: 14.0° to 32.0° <ul style="list-style-type: none"> • It is not recommended to install the main unit at an angle of more than 30°; otherwise, the malfunction may result. • Guidance is canceled when you change this setting.
	WAAS/EGNOS	Select whether to use WAAS and EGNOS to increase the accuracy of positioning. Off: Cancels. On: Activates.
	Language *5	Select the language used for on-screen information and voice guidance. English US, Español, Français
	Reset Calibration	Reset the calibration data in the following cases: <ul style="list-style-type: none"> • When you reinstall the unit to another car. • When you change Installation Angle. (☞ above) • When you replace or rotate the tires. Once this is carried out, the calibration data is cleared. Calibration starts when you exit from the menu. (☞ [9]) <ul style="list-style-type: none"> • Guidance is canceled when you reset the calibration data.
Measuring Units	Select the measuring units for distance. km / m, mi / ft	
Coordinates	Select the measuring units for coordinate degrees. Deg / Min / Sec. Deg / Milli / Micro	
Car Position	If you find your current position displayed on a wrong place on the map, use this setting to correct your position. Adjust the position with ◀◀▶▶ ▲▼, then the direction with ▲▼.	

*5 This setting is shared with the **Language** setting in AV Menu (☞ [90]).

Additional information



Initial settings

- If you select **On** for **Store Display Mode**, the system starts up in demonstration mode for shops, and the initial setup screen appears every time you turn on the unit after turning off and on the ignition switch. Select **Off** to obtain the full performance from the unit.

Basic operations

- In a small scale, the map scrolling may stop when the map view approaches the border of the map coverage. Scrolling resumes in a larger scale when you keep scrolling the map.

Searching for a place

- While driving at a speed greater than 6 mi/h (10 km/h), following operations are prohibited:
 - To enter a destination.

If you try to do these operations, the following screen appears, and you cannot continue the operation.

You cannot operate while driving. Operate again after stopping.

- The search result is displayed in North Up view regardless of your map view setting.
- The name you entered to search for a POI may be different from the name of the search result.

From the list of POI

- If no POI data exists for the selected city, **POI not found.** appears on the display. Press **BACK** until the city entry menu appears, then re-enter another city.

POI around a place/route

- If no POI data exists for the selected area, **POI not found.** appears on the display. Press **BACK** until the main categories list appears.

- POI search in **Along Route** is canceled if the guidance finishes or if rerouting starts before the search completes.

By coordinates

- If the entered position is out of the database, **Out of the map coverage.** appears on the display. Enter again.

Basic navigation procedure

- When you reach the area approximately within 100 ft (30 m) around the destination/via point, the Navigation System considers that you have reached your destination/via point.

How you are guided

- If GPS signal reception is poor, navigation guidance may not be correct.
- The System may not receive GPS signals in the following places...
 - in a tunnel or parking lot in the building
 - under an overhead road
 - in a place surrounded by high buildings or by closely standing trees.
- The position of your car may not be detected correctly in the following cases...
 - when running on a road close to the other one (e.g. a highway and ordinary road running in parallel)
 - when turning at an almost straight fork in the road
 - when running on a gridiron road
 - after taking a ferry, etc.
 - when running on a steep mountain road
 - when running on a spiral road
 - when turning left or right after running on a long straight road
 - when running in a zigzag line on a broad road
 - when starting your car shortly after starting the engine
 - when running for the first time after installing the unit
 - when changing tires or attaching chains on the tires

- when tire slip occurs continuously and frequently
- after running on areas other than a road (e.g. private lands or parking lots)
- after running in underground or tower type parking lots
- after rotating your car on a turntable
- after frequent stops and starts in a congestion
- when the accuracy of GPS is deteriorated intentionally
- when running on a road constructed recently
- The route calculated by the System is one of the possible routes to your destination. The route is not always the most appropriate one.
- If a street name is not available in the database, **Unnamed** appears in place of the street name.
- If no-exit roads (only entering the rotary from the roads is allowed) exist on the rotary, the no-exit roads can neither be shown in the route guidance on the display nor counted in the route guidance voice message.
- The following phenomena may occur even if the System is working correctly...
 - It may guide to a closed road or to a route requiring U-turn.
 - It may not guide to your destination if there is only a narrow road or no road to your destination.
 - It may not avoid a congestion even if **Bypass Traffic** is set to **Auto Reroute**.
 - It may show a different road name.
 - It may not ask you to turn at a junction even if you need to.
 - It may give a guidance different from the actual road condition.
 - It may give an incorrect distance information.

Arranging your route



























- Highways are always used to calculate the route if the distance to the destination is over 120 mi (200 km).
- If the destination cannot be reached without using highways, ferries, or toll roads, they are used to calculate the route without respect to the **Route Options** settings.
- A detour may not be calculated with **Avoid Section** depending on the route.

Traffic information on map

- When **Bypass Traffic** is set to **Manual Reroute**, the rerouting may be canceled while you are checking due to a change of traffic condition. The rerouting is also canceled if you do not confirm the rerouting in one minute.
- Traffic information service is only available in the 48 contiguous United States.

List of POI icons

	Gas Station
	Hotel
	Parking
	Restaurant
	Shopping
Travel	
	Agency/Info
	Air Transportation
	Airport
	City Finder
	Ground Transportation
	Others [Travel]
Recreation	
	Bowling
	Golf
	Outdoor
	Skiing
	Theme Park/Exercise
	Zoo
	Others [Recreation]
Entertainment	
	Casino
	Museum
	Night Club/Bar
	Theater
	Others [Entertainment]
Medical	
	Animal Health
	Drug Store/Pharmacy



	Emergency
	Hospital
	Lab/Facility
	Physician
	Others [Medical]
Financial	
	ATM
	Bank
	Service
Automotive	
	Rental
	Sales
	Service
	Others [Automotive]
Community	
	Agriculture/Farming
	Child Service
	Education
	Government/Administration
	Health/Safety
	Insurance
	Legal Service
	Manufacturing
	Multimedia
	Police/Fire
	Post Office
	Real Estate
	Religious
	Others [Community]



List of traffic icons

	Traffic Jam
	Road works
	Road is blocked or closed
	Traffic lane closed
	Accident
	Condition
	Other Caution Event
	Information
	Rain
	Snow
	Strong winds
	Fog

AV source operations in the map screen

Source		 
Tuner	Auto search.	Change preset stations.
Satellite radio	Change channels.	Change categories.
Disc	Change tracks.	Change titles/groups/folders.
Music server		Change albums.
CD changer		Change folders.
iPod/D. player		(No function)
Bluetooth Audio		(No function)

Radio



52 Listening to the radio

FM station automatic presetting	
—SSM (Strong-station Sequential Memory)	52
Manual presetting	53
Selecting preset stations	53
Assigning titles to stations	54
When an FM stereo broadcast is hard to receive	54
Tuning in to stations with sufficient signal strength	54

55 Listening to the satellite radio

Activating your subscription after connection	55
Selecting channels by channel number	57
Presetting channels	57
Selecting channels on the lists	58

Listening to the radio

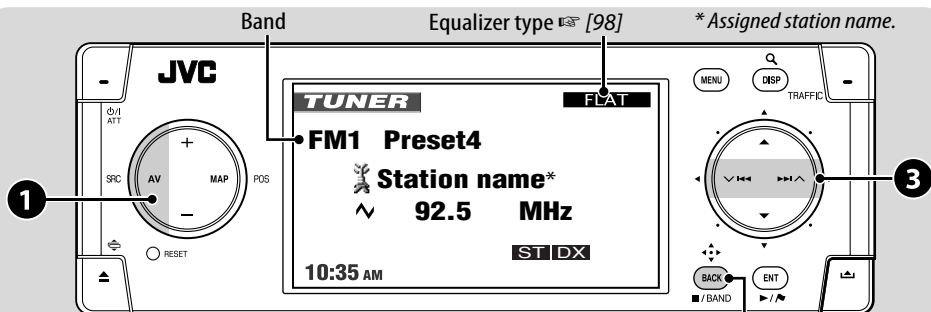

1 Select "TUNER."

2 Select the bands. →FM1→FM2→FM3→AM

3 Search for a station—Auto Search.

- Manual Search: Press and hold either **◀◀** or **▶▶** until **Manual Search** appears on the monitor, then press it repeatedly.
- **ST** lights up when receiving an FM stereo broadcast with sufficient signal strength.

FM station automatic presetting —SSM (Strong-station Sequential Memory)

This function works only for FM bands.
You can preset six stations for each band.

1 →FM1→FM2→FM3→AM

■ / BAND

2

3 **AV Menu**

⇒ **Mode**

⇒ **SSM**

4

▶ / ◀

SSM appears on the display.

Local FM stations with the strongest signals are searched and stored automatically in the FM band.

Manual presetting

You can preset six stations for each band.



2 Tune in to the station you want to preset.



3 Display the Preset List.

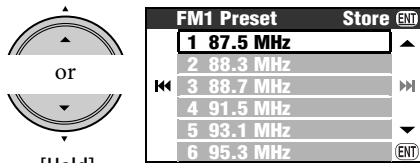

[Hold]

- For FM only: Each time you press and hold the button, you can change the bands.

4 Select a preset number.

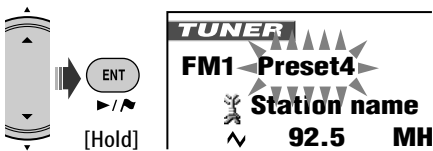

You can also access the Preset List through **AV Menu** ⇒ **List**.

Selecting preset stations

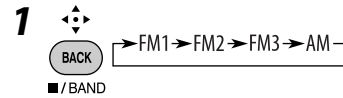

2 Select a preset number.

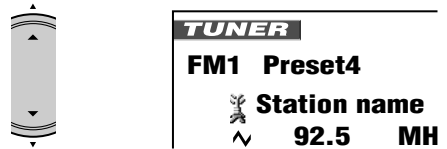

On the remote:

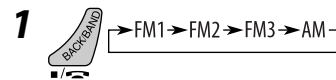

2 Select a preset number.



or

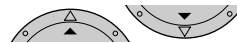

From the Preset List

1 Display the Preset List.

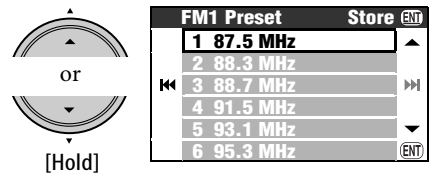

[Hold]

- For FM only: Each time you press and hold the button, you can change the bands.

2 Select a preset number.

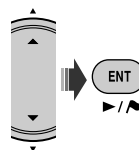

Assigning titles to stations

You can assign a title to up to 30 radio stations.

1 Tune in to the station you want to assign a title to.

2 

3 **AV Menu**
⇒ **Title Entry**



4 Assign the title.

- Inputting characters  [105]
- You can use up to 16 characters.

5 Select **Store**.

If [Name Full] appears

If you have assigned titles to 30 stations, you need to delete some titles to name new stations. After step **3** above...

1 
▶/▶

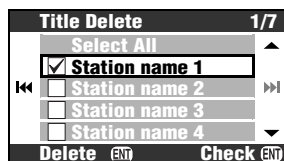

2 Select the titles to delete.

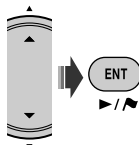

- Checkbox operations  [105]

3 Delete the selected titles.

▶/▶
[Hold]

When an FM stereo broadcast is hard to receive

1 

2 **AV Menu**
⇒ **Mode**
⇒ **Mono**
⇒ **On**

3 
▶/▶

MO lights up. Reception improves, but stereo effect will be lost.

To restore stereo effect, select **Off** in step **2**.

Tuning in to stations with sufficient signal strength

This function works only for FM bands.

Once you have activated this function (selected **Local**), it always works when searching for FM stations.

1 

2 **AV Menu**
⇒ **Mode**
⇒ **DX/Local**
⇒ **Local**

3 
▶/▶

LO lights up. Only stations with sufficient signal strength will be detected.

To tune in to all receivable stations again, select **DX** in step **2**.

Listening to the satellite radio

Before operating, connect either one of the following (separately purchased) to the CD changer jack on the rear of this unit.

- **JVC SIRIUS radio DLP**—Down Link Processor, for listening to the SIRIUS Satellite radio.
- **XMDirect™ Universal Tuner Box**—With a JVC Smart Digital Adapter (XMDJVC100: not supplied), for listening to the XM Satellite radio.

Activating your subscription after connection

■ For SIRIUS Radio

1 Turn on the power.



ⓘ/ⓐ

2 Select “SAT” for the source.



ⓘ/ⓐ

JVC DLP starts updating all the SIRIUS channels. (ⓘ “GCI update” below.)

- Once completed, JVC DLP tunes in to CH184 (channel for subscription guidance).

3 Check your SIRIUS ID.

ⓘ [93]

4 Activate your subscription.

Contact SIRIUS on the Internet at <<http://activate.siriusradio.com/>>, or call SIRIUS toll-free at 1-888-539-SIRIUS (7474).

- “Subscription Updated Press Any Key to Continue” appears on the monitor once subscription has been completed.

■ For XM Radio

1 Turn on the power.



ⓘ/ⓐ

2 Select “SAT” for the source.



ⓘ/ⓐ

XMDirect™ Universal Tuner Box starts updating all the XM channels. “Channel 1” is tuned in automatically. (ⓘ “GCI update” below.)

3 Check your XM Satellite radio ID.

It is labelled on the casing of the XMDirect™ Universal Tuner Box. You can also check it by tuning in to “Channel 0” (ⓘ *next page*).

4 Activate your subscription.

Contact XM Satellite radio on the Internet at <<http://xmradio.com/activation/>> to activate your subscription, or you can call 1-800-XM-RADIO (1-800-967-2346).

- Once completed, the unit tunes in to one of the available channels (Channel 4 or higher).

GCI (Global Control Information) update:

- If channels are updated after subscription, updating starts automatically, and no sound can be heard.

For SIRIUS: “Channels Updating XX% completed” appears.

For XM: “UPDATING” appears.

- Update takes a few minutes to complete.
- Do not press any button or perform any operation until updating is completed.

Switches the display to program information—artist name/song name(/ composer name: only for SIRIUS Satellite radio).

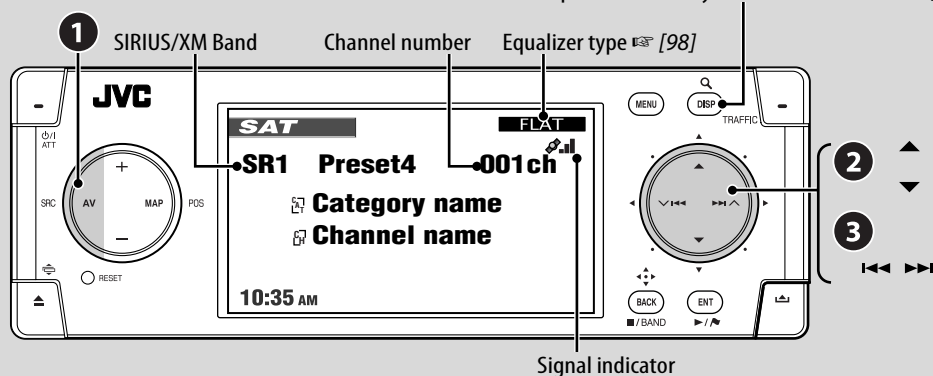

■ For SIRIUS Radio

- 1 Select "SAT."
- 2 Select a category.
 - To select a channel from all categories, select "ALL."
- 3 Select a channel to listen to.
 - Holding either ◀◀ or ▶▶ changes the channels rapidly.
 - While searching, invalid and unsubscribed channels are skipped.

■ For XM Radio

- 1 Select "SAT."
- 2 Select a category.
 - To select a channel from all categories (including non-categorised channels), skip this step.
 - If you do not select a channel within 15 seconds, the category selected is canceled. You can select a channel from all categories now.
- 3 Select a channel to listen to.
 - Holding either ◀◀ or ▶▶ changes the channels rapidly.
 - While searching, invalid and unsubscribed channels are skipped.

Checking the XM Satellite radio ID

Select channel "0."

The 8-digit (alphanumeric) ID number is displayed on the monitor.

To cancel the ID number display, select any channel other than channel "0."

Selecting channels by channel number

On the remote only:

1 **DIRECT** CLEAR



2 Input the channel number in three digits.

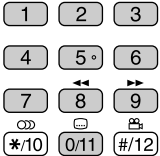

Presetting channels

You can preset six channels for each band.

1 Tune in to a channel you want to preset.

2 Display the Preset List.

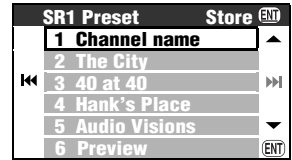

- Each time you keep pressing the button, you can change the bands.

3 Select a preset number.

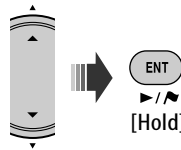

- You can also access the Preset List through **AV Menu** ⇒ **List** ⇒ **Preset List**.

- “SIRIUS” and the SIRIUS dog logo are registered trademarks of SIRIUS Satellite Radio Inc.
- XM and its corresponding logos are registered trademarks of XM Satellite Radio Inc.
- “SAT Radio”, the SAT Radio logo and all related marks are trademarks of SIRIUS Satellite Radio Inc., and XM Satellite Radio, Inc.

Selecting preset channels

1 Display the Preset List.



SR1 Preset	Store	ENT
1 Channel name		▲
2 The City		
3 40 at 40		▶▶
4 Hank's Place		
5 Audio Visions		▼
6 Preview		ENT

- Each time you keep pressing the button, you can change the bands.

2 Select a preset number.

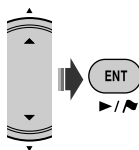

On the remote:

1 Select the bands.

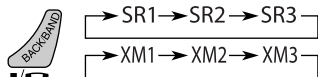

2 Enter the preset number.

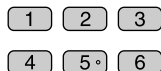

Selecting channels on the lists

You can select a channel using one of the following lists—Preset list/Category list/Channel list.

1 MENU

2 AV Menu

⇒ List

⇒ Preset List/
Category List/
Channel List

- **Preset List:** left column
- **Category List:** Displays the categories.
→ Select a category, then a channel within the selected category.
- **Channel List:** Displays all channels (XM) or all channels within the current category (SIRIUS). → Select a channel.

3 Select (a category, then) a channel.

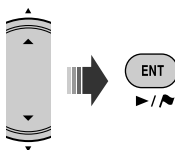

- You can also access the Category List by...



Discs and HDD



60 Disc operations

Playable discs/files	61
Selecting playback modes	64
Selecting tracks on the list	65
Prohibiting disc ejection	65
Remote operations	65
Special functions for DVD Audio	68
Operations using the on-screen bar	68

70 Music server operations

Selecting tracks using lists	71
Selecting playback modes	71
Recording/copying tracks from a disc	72
Editing the library	75
Checking the remaining storage size	76

77 CD changer operations

Selecting playback modes	78
--------------------------	----

Disc operations

To insert a disc

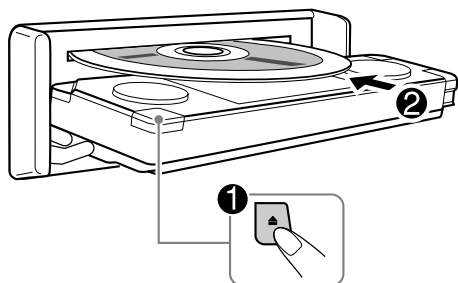

The disc type is automatically detected, and playback starts automatically (for some discs: automatic start depends on its internal program).
If a disc does not have any disc menu, all tracks in it will be played repeatedly until you change the source or eject the disc.

To eject the disc

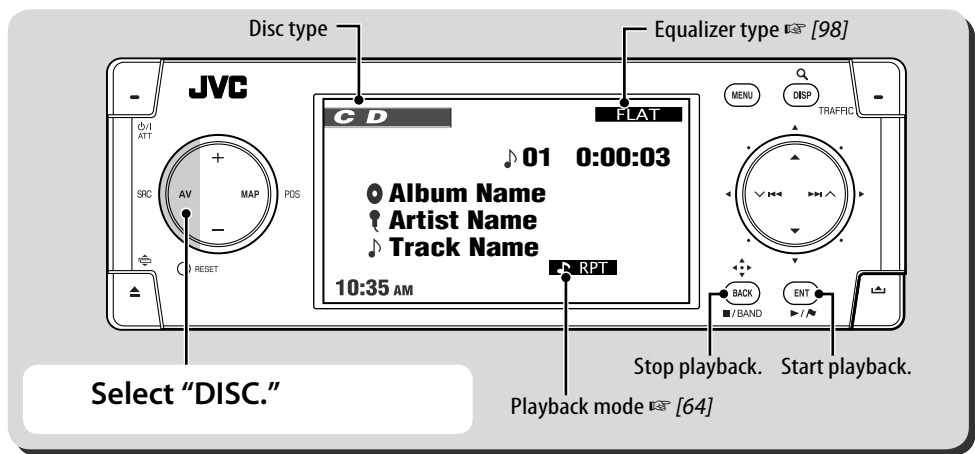

Each time you press DISP, the display changes. 

For picture discs: playback picture → disc information → vehicle information (☰ [11]) → Video input* (☰ [82]) → (back to the beginning)

For audio discs: disc information → vehicle information → Video input* → (back to the beginning)

When a disc contains different types of file (music, movie or still pictures), you need to select the file type to play back. (☰ [91] **File Type**)

If "⊘" appears on the monitor, the unit cannot accept the operation you have tried to do.

- In some cases, without showing "⊘," operations will not be accepted.

* Appears only when you have selected **Video** or **Camera** for **Video Input** setting (☰ [93]).

- For discs except DVD and VCD: The control screen appears on the connected external monitor. (☰ [102])

Playable discs/files

Disc type	Recording format, file type, etc.	Playable
<i>DVD</i>	DVD Video	✓OK
	DVD Audio	✓OK
	DVD-ROM	✗NO
<i>DVD Recordable/Rewritable (DVD-R*1/-RW, +R/+RW*2)</i> • Compliant to UDF bridge format • DVD-RAM cannot be played.	DVD Video	✓OK
	DivX/MPEG1/MPEG2	
	JPEG	
	MP3/WMA/WAV	✗NO
	ASF	
	DVD-VR, DVD+VR	
<i>Dual Disc</i>	DVD side	✓OK
	Non-DVD side	✗NO
<i>CD/VCD</i>	Audio CD/CD Text (CD-DA), DTS-CD	✓OK
	VCD (Video CD)	✓OK
	CD-ROM	✗NO
	CD-I (CD-I Ready)	
<i>CD Recordable/Rewritable (CD-R/-RW)</i> • Compliant to ISO 9660 level 1, level 2, Romeo, Joliet	CD-DA	✓OK
	MP3/WMA/WAV	
	DivX/MPEG1/MPEG2	
	JPEG	
	MPEG4	✗NO

*1 DVD-R recorded in multi-border format is also playable (except for dual layer discs).

*2 It is possible to play back finalized +R/+RW (Video mode only) discs. However, the use of +R double layer disc is not recommended.

- This unit is not compatible with Multiple Bit Rate (MBR; a file that contains the same content encoded at several different bit rates).

Note on Region Code:

DVD players and DVD Video discs have their own Region Code numbers. This unit can only play back DVD discs whose Region Code numbers include "1."



If you insert a DVD Video disc of an incorrect Region Code, **Region Code Error** appears on the monitor.

CD

DTS icon (only for DTS-CDs) * Only for CD-Text. "No Name" appears for conventional CDs.

Track no./Playing time

Press: Select track
Hold: Reverse/forward search*¹

MP3, WMA, WAV

Folder no./File no./Playing time

Audio format

* Tag data will be shown instead of folder/file names when they are recorded and Tag Display is set to On. [90]

Press: Select file
Hold: Reverse/forward search*¹

▼, ▲
Press: Select folder
Hold: Display Folder List

DivX, MPEG

Folder no./File no./Playing time

File type

Press: Select file
Hold: Reverse/forward search*²

▼, ▲
Press: Select folder
Hold: Display Folder List

DVD Video



Title no./Chapter no./Playing time Audio format

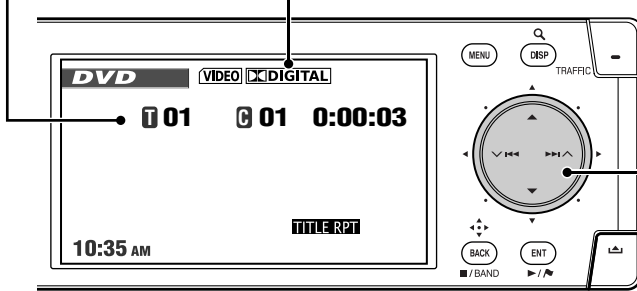

Press: Select chapter
 Hold: Reverse/forward search*1
,
 Press: Select title

DVD Audio



Group no./Track no./Playing time Audio format

BONUS indicator [68]
B.S.P indicator [68]

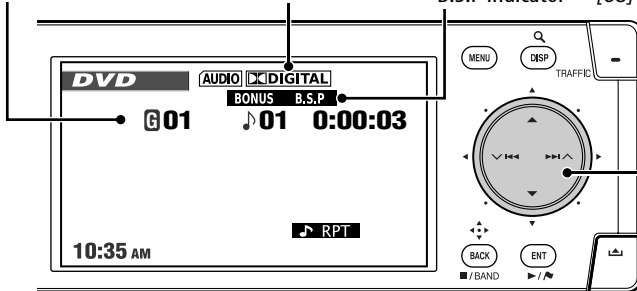

Press: Select track
 Hold: Reverse/forward search*1
,
 Press: Select group

VCD



Track no./Playing time PBC indicator: lights up when PBC is in use. [67]

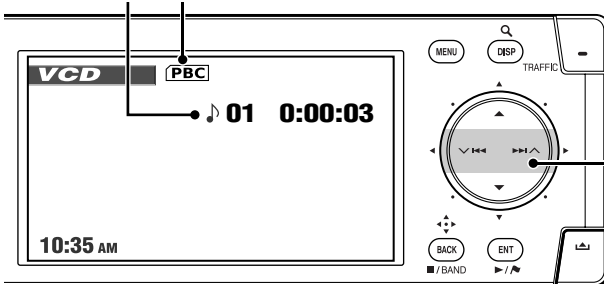

Press: Select track
 Hold: Reverse/forward search*1

*1 Search speed: x2 ⇔ x10

*2 Search speed: ►► 1 ⇔ ►► 2

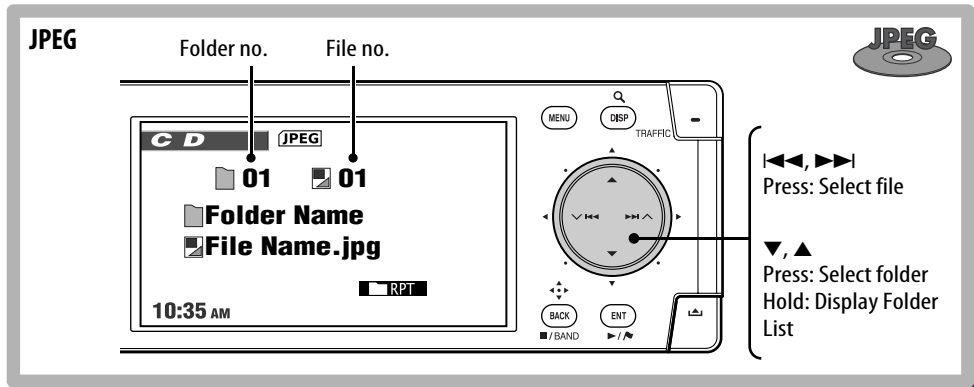

Selecting playback modes

You can use only one of the following playback modes—**Intro/Repeat/Random**.

Ex. To select Track Repeat

1

2 **AV Menu**

⇒ **Mode**

⇒ **Repeat**

⇒ **Track**

3

When one of the playback modes is selected, the corresponding indicator lights up on the disc information screen.

To cancel, select **Off** in step 2.

<i>Disc type</i>	Repeat
	Chapter: Repeats current chapter
	Title: Repeats current title
	Track: Repeats current track
	Track: Repeats current track
	Folder: Repeats current folder
	Folder: Repeats current folder

<i>Disc type</i>	Intro	Repeat	Random
 	Track: Plays the first 15 seconds of each track (for VCD: PBC not in use)	Track: Repeats current track (for VCD: PBC not in use)	Disc: Randomly plays all tracks (for VCD: PBC not in use)
	Track: Plays the first 15 seconds of each track Folder: Plays the first 15 seconds of the first track of each folder	Track: Repeats current track Folder: Repeats all tracks of the current folder	Folder: Randomly plays all tracks of current folder, then tracks of next folders Disc: Randomly plays all tracks

Selecting tracks on the list

If a disc includes folders, you can display the Folder/Track Lists, then start playback.

1 Display the Folder List.

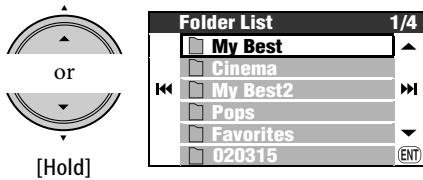

2 Select a folder, then a track.

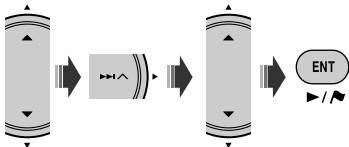

- If you press ENT while a folder is selected, all tracks in the selected folder are played back.

You can also access the Folder List through **AV Menu** ⇨ **List**.

Prohibiting disc ejection

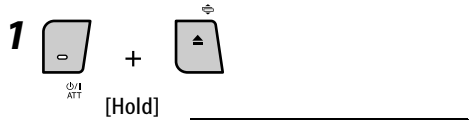

2 Select **No Eject**.

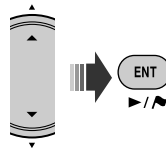







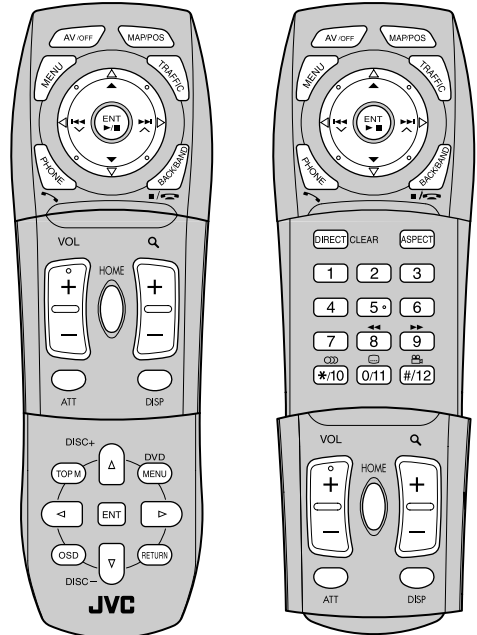

To cancel the prohibition, select **Eject OK** in step 2.





Remote operations

Common operations

AV/OFF	<ul style="list-style-type: none"> • Change the source. • Turn off the AV function if pressed and held.
MAP/POS	Switch to the map screen.
ENT ▶/⏸	Start playing/pause. (For JPEG: Slide show)
BACK/BAND	Stop playing.
MENU	Call up AV Menu.
VOL +/-	Adjust the volume.
ATT	Attenuate/restore the sound.
DISP	Change the display. [11]
OSD	Display the on-screen bar. [68]
ASPECT	Change the aspect ratio of the playback pictures.



		
	Press: Select a chapter. Press and hold: Reverse/forward search* ¹ .	Press: Select a track. Press and hold: Reverse/forward search* ¹ .
	Select a title.	Select a group.
DIRECT (see below)	Chapter → Title → Off ↑	Track → Group → Off ↑
	Reverse/forward search* ² Slow motion* ³ during pause. (No sound can be heard.)	Reverse/forward search* ²
	Select audio language.	
	Select subtitle language.	—
	Select a view angle.	—

		
	Press: Select a track. Press and hold: Reverse/forward search* ¹	
	—	Select a folder.
DIRECT (see below)	Track → Off ↑	File → Folder → Off ↑
	Reverse/forward search* ²	

Selecting an item with number keys

You can select a chapter/title/group/folder/track by inputting its number.

Ex.: To select a title of a DVD Video.

1  [twice]

On the playback screen:



TITLE → -- appears on the screen.



On the disc information screen:



The title number lights up in gray.

- Each time you press , the selectable item changes. See the table above.

2 Input the title number.

- To correct a misentry, press **DIRECT** to clear the entry and input again.

3 

Press: Select a track. Press and hold: Reverse/forward search ^{*4} . (No sound can be heard.)	Press: Select a track. Press and hold: Reverse/forward search ^{*1} . (No sound can be heard.)	Press: Select a track.
Select a folder.	—	Select a folder.
Track → Folder → Off 	Track → Off 	File → Folder → Off
Reverse/forward search ^{*5} (No sound can be heard.)	Reverse/forward search ^{*2} Forward slow motion ^{*3} during pause. (No sound can be heard.)	—
Select audio language. (Only for DivX.)	Select audio channel.	—
Select subtitle language. (Only for DivX.)	—	—
—	—	—

*1 Search speed: x2 ⇒ x10

*2 Search speed: x2 ⇒ x5 ⇒ x10 ⇒ x20 ⇒ x60

*3 Slow motion speed: 1/32 ⇒ 1/16 ⇒ 1/8 ⇒ 1/4 ⇒ 1/2

*4 Search speed: ►►1 ⇒ ►►2

*5 Search speed: ►►1 ⇒ ►►2 ⇒ ►►3

Menu driven operations

(For DVD and DivX 6)



1 or (only for DVD Video and DivX)



2 Select an item you want to play.



3

Quick skip

Return/advance the scenes by 5 minutes.

While playing...



current playback position

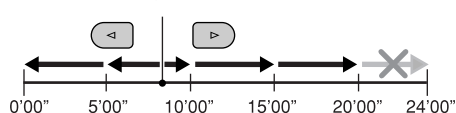

PBC playback

Select an item on the menu.

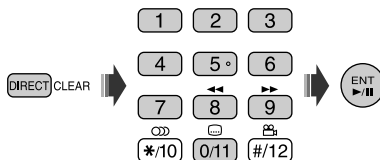

- To return to the previous menus, press .

To cancel PBC playback



2 Select a track.

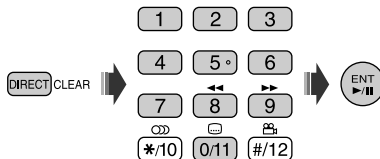

- To resume PBC, press / .

Special functions for DVD Audio

Playing back a bonus group **BONUS**

If a DVD Audio including a “bonus group” is detected, **BONUS** lights up on the disc information screen.

1 Select the bonus group.

- The bonus group is usually recorded as the last group.

2 Enter the key number.

-  next column “To enter numbers”
- “Key number” (a kind of password) for the bonus group is not open to public. The way of getting the key number depends on the disc.

3 Follow the interactive instructions shown on the monitor.

Selecting browsable still pictures **B.S.P**

When a disc including browsable still pictures is detected, **B.S.P** lights up on the disc information screen.

When disc shows the BSP selecting icons such as  or  on the screen...

1 Select an item you want to display.



2

Operations using the on-screen bar

For DVD/VCD/DivX/MPEG/JPEG discs, you can check the disc information and use some functions through the on-screen bar.

1 Display the on-screen bar.

 [twice]

- When you press OSD once, the information bar appears. When you press it again, the operation bar spreads out below.

2 Select an item.



3 Make a selection.



If pop-up menu appears...



- For entering time/numbers, see below.

To remove the on-screen bar



To enter numbers

1 Select a number.



2 Move to the next digit.



3 Repeat steps 1 and 2.

4

- To correct a misentry, use .
- It is not necessarily required to enter trailing zeros.

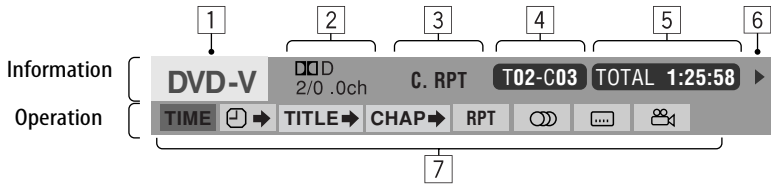

1 Disc type

2 Audio signal format (for DVD)

PBC (for VCD)

3 Playback mode

T. RPT Title Repeat/Track Repeat*

C. RPT Chapter Repeat*

F. RPT Folder Repeat*

D. RND Disc Random*

T. INT Track Intro*

4 Playback information

T02-C03 Current title/chapter

G02-T03 Current group/track

TRACK 01 Current track

F001-T001 Current folder/track

F001-F001 Current folder/file

5 Time indication

TOTAL Elapsed playing time of the disc

T. REM Remaining title/group time (for DVD)

Remaining disc time (for others)

TIME Elapsed playing time of the current chapter/track

REM Remaining time of the current chapter/track

6 Playback status

▶ Play

◀ / ▶ Reverse/forward search

◀ / ▶ Reverse/forward slow-motion

⏸ Pause

■ Stop

7 Operation icons

TIME Change time indication (⏮ [5])

⏮ → Time Search (Enter the elapsed playing time of the current title or of the disc.)

TITLE → Title Search (by its number)

GROUP → Group Search (by its number)

CHAP → Chapter Search (by its number)

TRACK → Track Search (by its number)

RPT Repeat play*

INT Intro play*

RND Random play*

🗣 Change the audio language or audio channel

🗣 Change the subtitle language or hide the subtitle.

📺 Change the view angle

PAGE 1/15 Change the B.S.P (for DVD Audio) (The numbers in the indicator show the current page/ total page number.)

* ⏮ [64]

Music server operations

The built-in HDD works not only as storage for navigation data, but as a music server, where you can record CD tracks and music files (MP3, WMA and WAV files).

The recorded tracks are categorized into genres and albums.

You can make 99 genres in the music server, and 99 albums in each genre. Each album can contain 999 tracks.

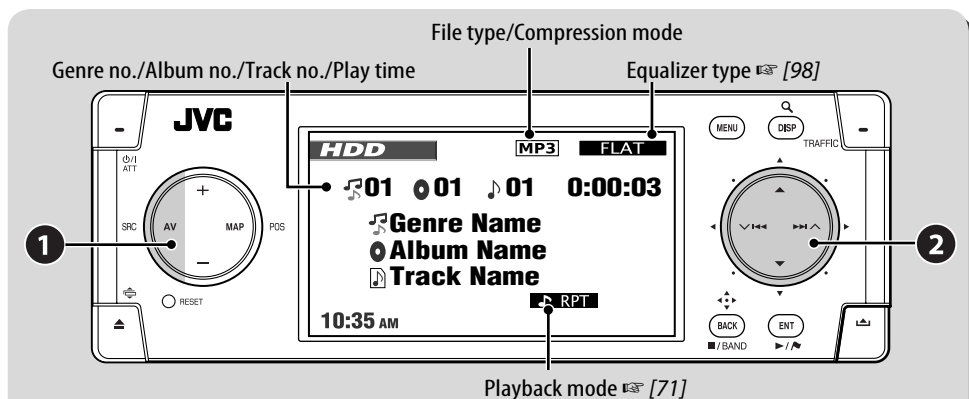
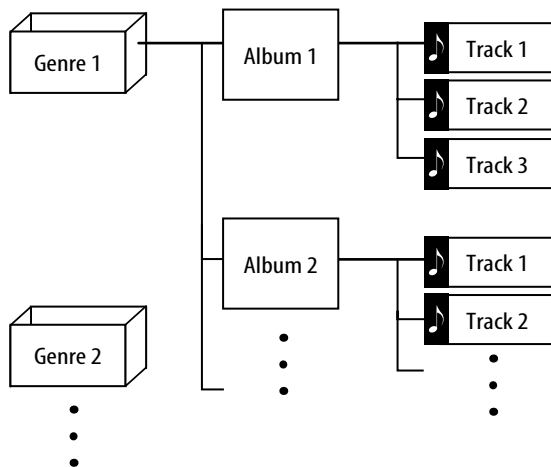

1 Select "HDD."

The last selected track starts playing from the beginning.

2 Select the track.

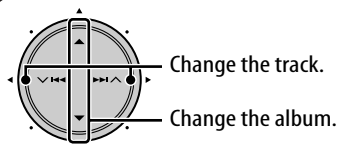

Selecting tracks using lists

1 Call up the Genre List.

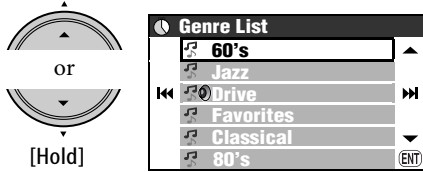

2 Select a genre, then an album.

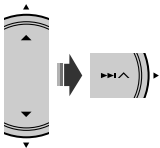

- Repeat the same procedure to select the album.

3 Select a track to play back.

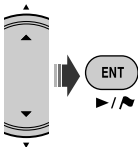

- If you press ENT while a genre or an album is selected, all tracks in the selected genre or album are played back.

You can also access the Genre List through **AV Menu** ⇒ **List**.

Selecting playback modes

You can use only one of the following playback modes—**Intro/Repeat/Random**.

Ex. To select Track Repeat

- 1 **MENU**
- 2 **AV Menu**
⇒ **Mode**
⇒ **Repeat**
⇒ **Track**
- 3 **ENT**
▶/⏪

When one of the playback modes is selected, the corresponding indicator lights up on the monitor.

To cancel, select **Off** in step 2.

<p>Intro</p> <p>INT</p>	<p>Track: Plays the first 15 seconds of all tracks in the current album</p> <p>Album: Plays the first 15 seconds of the first tracks of each album in the current genre</p> <p>Genre: Plays the first 15 seconds of the first tracks of each genre</p>
<p>Repeat</p> <p>RPT</p>	<p>Track: Repeats current track</p> <p>Album: Repeats all tracks of the current album</p> <p>Genre: Repeats all tracks of the current genre</p>
<p>Random</p> <p>RND</p>	<p>Album: Randomly plays all tracks of the current album</p> <p>Genre: Randomly plays all tracks of the current genre</p> <p>All: Randomly plays all tracks in the music server</p>

Recording/copying tracks from a disc

- You can record tracks of audio CDs into the HDD. **Record** appears in **AV Menu**.
- You can copy music files (MP3, WMA, WAV) into the HDD. **Copy** appears in **AV Menu**.

Preparation:

Insert the disc to record/copy, and select DISC as the source.

- While recording an audio CD, you cannot listen to the tracks being recorded with the map screen displayed.
- While copying music files, you cannot listen to them.
- You cannot change the source while recording or copying tracks. If you want to interrupt the recording and enjoy another source, cancel the recording/copying (see below).

When the recording/copying is finished Completed is displayed, and playback resumes.

To cancel recording/copying

While recording or copying...

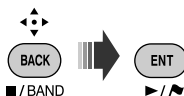

You can also cancel recording/copying through **AV Menu** ⇒ **Record/Copy** ⇒ **Cancel**.

Notes on the name of new genres and albums

- If you want to make a new genre or a new album for the tracks to be recorded/copied, select **[New Genre]** or **[New Album]**. To name the new genre/album, press and hold DISP. You can also name it later through **Title Entry** (see [75] “Changing the titles”).
- If you do not specify a genre name or album name on recording/copying, they are assigned as follows.
 - For audio CDs, the genre name and album name are assigned automatically using the recording date and time.
 - For music files, the genre name is assigned automatically using the recording date and time. The original folder name and file name are used as the album name and the track name.

To record the current track

- 1 MENU
- 2 **AV Menu**
⇒ **Record**
⇒ **Current Track**
- 3 **Start recording.**



Recording... appears.

- The track is recorded in the **High Quality** mode. (see next page)
- When you record a track for the first time with this function, a new genre and a new album is automatically created for the track. Other tracks recorded with this function are recorded into the same album until you turn off the ignition switch or edit the library.

To record all the tracks in a disc

1 

2 AV Menu

⇒ Record

⇒ Select All

3 Select the genre and album to record the tracks into.

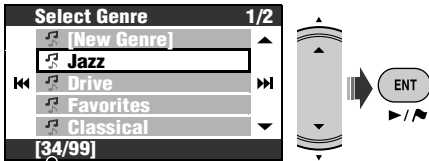

Number of albums in the selected genre

- Repeat the same procedure to select the album.

4 Select a compression mode.

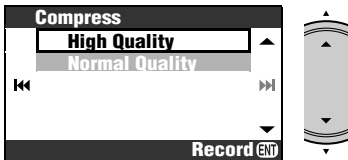

High Quality: High quality lossless recording (LLC).

Normal Quality: More compressed recording, so data size becomes smaller (BSC).

5 Start recording.



Recording... appears.

To record selected tracks

1 

2 AV Menu

⇒ Record

⇒ Select Track

3 Select the tracks to record.

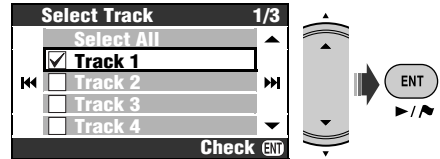

- Checkbox operations  [105]

4

5 Select the genre and album to record the tracks into.

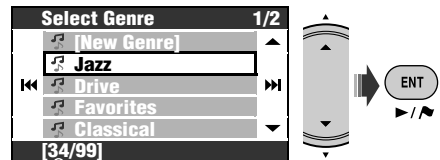

Number of albums in the selected genre

- Repeat the same procedure to select the album.

6 Select a compression mode.



High Quality: High quality lossless recording (LLC).

Normal Quality: More compressed recording, so data size becomes smaller (BSC).

7 Start recording.



Recording... appears.

To copy the current track

- 1 
- 2 **AV Menu**
⇒ **Copy**
⇒ **Current Track**
- 3 Start copying.



Copying... appears.

- When you copy a track for the first time with this function, a new genre and a new album is automatically created for the track. Other tracks copied with this function are copied into the same album until you turn off the ignition switch or edit the library.

To copy all the tracks in a folder

- 1 Select the target folder.
- 2 
- 3 **AV Menu**
⇒ **Copy**
⇒ **Select All**
- 4 Select the genre to copy the tracks into.

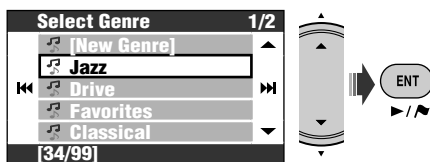

Number of albums in the selected genre

- 5 Select the album to copy the tracks into.

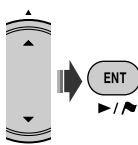



Copying... appears, and copying starts.

To copy selected tracks

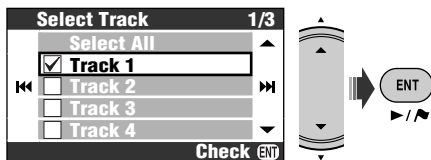
- 1 
- 2 **AV Menu**
⇒ **Copy**
⇒ **Select Track**
- 3 Select the tracks to copy.



- Checkbox operations  [105]

- 4 
- 5 Select the genre to copy the tracks into.

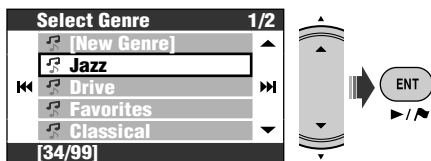

Number of albums in the selected genre

- 6 Select the album to copy the tracks into.

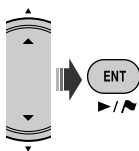

Copying... appears, and copying starts.

To resume the interrupted recording/copying

If have turned off the power, switched off the car ignition switch, or detached the control panel while recording/copying, you can resume the last recording/copying.

- If you eject the disc or edit the library of the music sever, **Continue** mode is canceled.
- You cannot use **Continue** if you have canceled recording/copying manually.

1 

2 AV Menu

⇒ **Record** or **Copy**

⇒ **Continue**

3 Start recording/copying.





Recording.../Copying... appears.

Editing the library

- Library editing is possible only when HDD is selected as the source.

Changing the titles

You can change the names of genres, albums and tracks in the HDD.

Ex. To change the name of a track

1 

2 AV Menu

⇒ **Title Entry**

3 Select a genre, then an album.

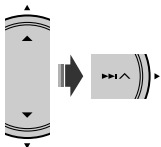

Playback of the selected item starts.

- Repeat the same procedure to select the album.

4 Select a track to edit.



5 Enter the name.

- Inputting characters  [105]
- You can use up to 32 characters for the name of tracks, albums, or genres.

6 Select **Store** to finish editing.

- You cannot edit the tag data of tracks.

Moving tracks between albums/Moving albums between genres

Ex. To move tracks between albums

- Select the album which the target tracks belong to.

1 

2 AV Menu

⇒ **Edit**

⇒ **Move**

⇒ **Track**

3 Check the tracks to move.

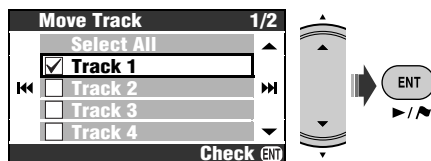

- Checkbox operations  [105]

4

5 Select the album to move the tracks into.

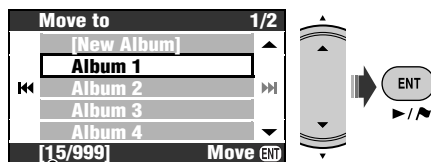

Number of tracks in the selected album

6 Move the selected tracks.





A confirmation message appears. Press ENT to confirm the operation. Press BACK to cancel.

Rearranging the order of tracks, albums and genres

Ex. To rearrange the order of tracks in an album

- Select the album which the target tracks belong to.

1 

2 AV Menu

⇒ **Edit**

⇒ **Sort**

⇒ **Track**

3 Select the track to move.

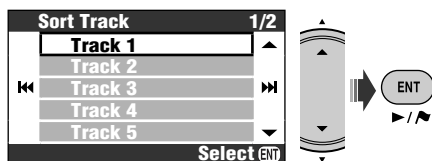

4 Move the selected track.

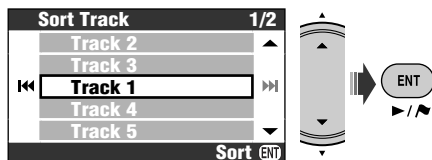

A confirmation message appears. Press ENT to confirm the operation. Press BACK to cancel.

- To rearrange more tracks, repeat steps 1 to 4.

Deleting tracks, albums, or genres

Ex. To delete tracks

- Select the album which the target tracks belong to.

1 

2 AV Menu

⇒ **Edit**

⇒ **Delete**

⇒ **Track**

3 Check the tracks to delete.

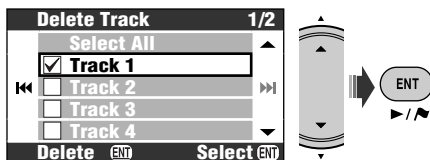

- Checkbox operations  [105]

4 Delete the selected tracks.



▶/⏪

[Hold]

A confirmation message appears. Press ENT to confirm the operation. Press BACK to cancel.

Checking the remaining storage size

1 

2 AV Menu

⇒ **Edit**

⇒ **HDD Free Area**

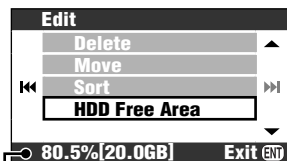

Free space of the music server

CD changer operations

It is recommended to use a JVC MP3-compatible CD changer with your unit.

- You can play only CDs (CD-DA) and MP3 discs.

Preparation:

Make sure **Changer** is selected for the external input setting. (☞ [93])

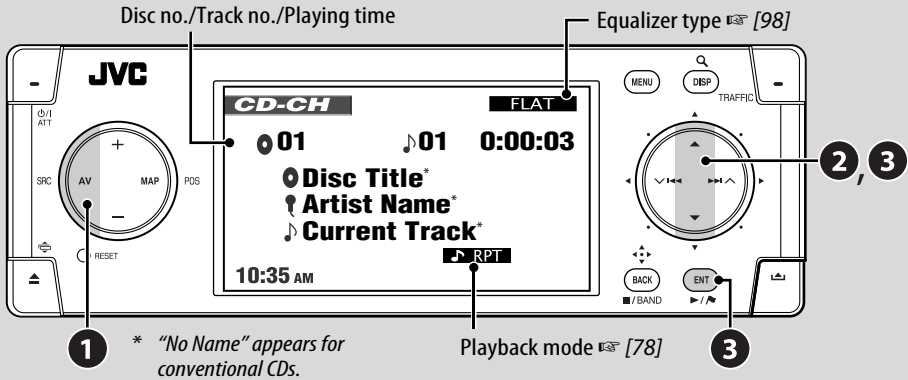

1 Select "CD-CH."

Playback starts automatically.

2 Display the Disc List.

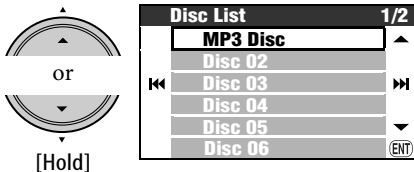

- Each time you hold the button, you can display the other list of the remaining discs.

3 Select a disc to start playing.

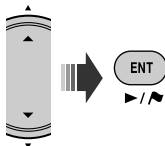

To select tracks

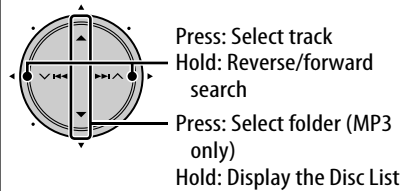

On the remote:

To select a disc

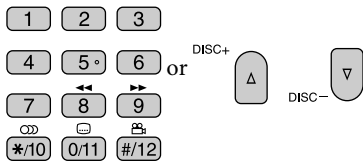

: Select folder (MP3 only)

: Select track

Selecting playback modes

You can use only one of the following playback modes—Intro/Repeat/Random.

Ex. To select Track Repeat

1

2 **AV Menu**

⇒ **Mode**

⇒ **Repeat**

⇒ **Track**

3

When one of the playback modes is selected, the corresponding indicator lights up on the monitor.

To cancel, select **Off** in step 2.

Disc type	Intro	Repeat	Random
	<p>Track: </p> <p>Plays the first 15 seconds of each track</p> <p>Disc: </p> <p>Plays the first 15 seconds of the first track of all loaded discs</p>	<p>Track: </p> <p>Repeats current track</p> <p>Disc: </p> <p>Repeats all tracks of the current disc</p>	<p>Disc: </p> <p>Randomly plays all tracks of the current disc</p> <p>All: </p> <p>Randomly plays all tracks of all loaded discs</p>
	<p>Track: </p> <p>Plays the first 15 seconds of each track</p> <p>Folder: </p> <p>Plays the first 15 seconds of the first track of each folder</p> <p>Disc: </p> <p>Plays the first 15 seconds of the first track of all loaded discs</p>	<p>Track: </p> <p>Repeats current track</p> <p>Folder: </p> <p>Repeats all tracks of the current folder</p> <p>Disc: </p> <p>Repeats all tracks of the current disc</p>	<p>Folder: </p> <p>Randomly plays all tracks of current folder, then tracks of next folders</p> <p>Disc: </p> <p>Randomly plays all tracks of the current disc</p> <p>All: </p> <p>Randomly plays all tracks of all loaded discs</p>

- You can also access the Disc List through **AV Menu** ⇒ **List**.
- While playing an MP3 disc, you can select and start playing a track in the disc using the Lists.

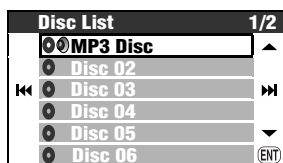

Other functions

- 80 iPod/D. player operations**
 - Selecting a track from the player's menu 80
 - Selecting playback modes 80

- 81 Playing other external components**
 - External input 81
 - Video input 82

- 83 Using Bluetooth® devices**
 - Cellular phone/audio player
 - Menu operation for Bluetooth devices 83
 - Registering a Bluetooth device 83
 - Using the Bluetooth cellular phone 85
 - Using the Bluetooth audio player 87
 - Phone Menu 88

- 90 AV Menu items**

- 98 Sound equalization**
 - Selecting an equalizer type 98
 - Storing your own adjustment 98

- 99 Additional Information**

iPod/D. player operations

For Apple iPod and JVC D. player, it is required to connect the interface adapter (KS-PD100 for iPod or KS-PD500 for D. player) to the CD changer jack on the rear.

Preparation:

Make sure **Changer** is selected for the external input setting. (☞ [93])

1 Select "iPod" or "D. PLAYER."
Playback starts automatically.

2 Select a track.

Playback mode ☞ below

Pause/Resume

Equalizer type ☞ [98]

Selecting a track from the player's menu

1 Enter the player's menu.



SEARCH appears.

- This mode will be canceled if no operations are done for about 5 seconds.

2 Select the desired menu item.



3 Confirm the selection.



4 Repeat steps 2 and 3 to select a track.

- When a track is selected finally, playback starts.
- To return to the previous menu...



Selecting playback modes

1 **MENU**

2 **AV Menu**

⇒ **Mode**

⇒ **Repeat** or **Random**

Repeat

RPT

One:

Functions the same as "Repeat One" or "Repeat Mode → One."

All: **ALL**

Functions the same as "Repeat All" or "Repeat Mode → All."

Random

RND

Song **SONG /On:**

Functions the same as "Shuffle Songs" or "Random Play → On."

Album:

Functions the same as "Shuffle Albums" of the iPod.

To cancel, select **Off** in step **2**.

- iPod is a trademark of Apple Inc., registered in the U.S. and other countries.

Playing other external components

External input

You can connect an external component to the CD changer jack on the rear using the Line Input Adapter—KS-U57 (not supplied) or AUX Input Adapter—KS-U58 (not supplied).

Preparation:

Make sure **Ext Input** is selected for the external input setting. (☞ [93])

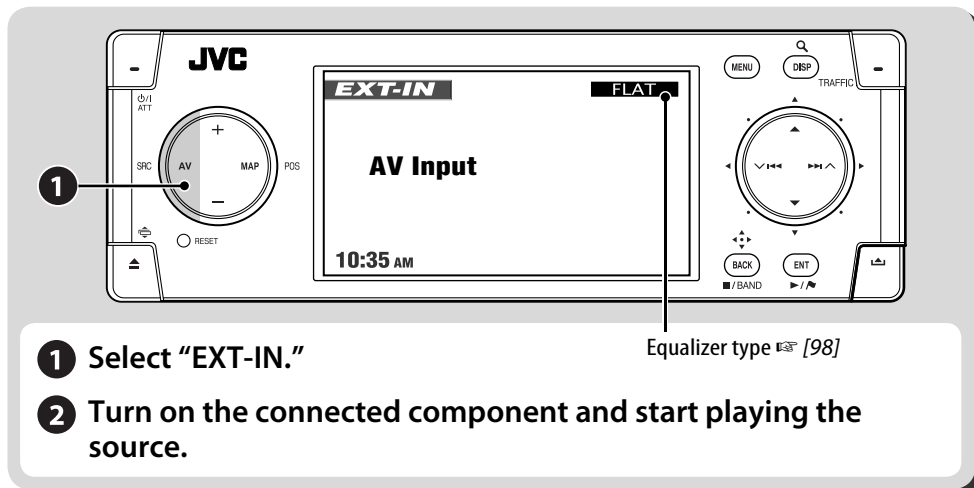

Assigning title to the external input

1 Select **EXT-IN** as the source.

2 **MENU**

3 **AV Menu**

⇒ **Title Entry**



4 Assign a title.

- Inputting characters ☞ [105]
- You can use up to 16 characters.

5 Select **Store**.

- While driving at a speed greater than 6 mi/h (10 km/h), operations of inputting are prohibited.

Video input

You can connect an external component to the VIDEO IN plug.

Preparation:

When connecting a video component

Make sure **Ext Input** is selected for the external input setting, and **Video** for the video input setting. (☞ [93])

- You cannot view the video picture when the parking brake is not engaged.

When connecting a camera

Make sure **Camera** is selected for the video input setting. (☞ [93])

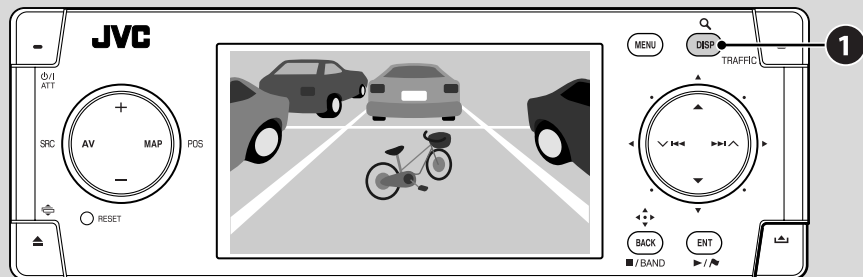

Each time you press DISP, the display switches as follows:

AV screen → Vehicle information (☞ [11]) → **Video picture or camera picture** → (Back to the AV screen)

For video components:

2 Turn on the connected component and start playing.

To switch to the camera view automatically

You can set the unit to automatically display the camera view when the car is put into reverse gear or when the car slows down.

☞ [94] **Interlock**

To reverse the camera picture

☞ [94] **Horizontal** and **Vertical**

Using Bluetooth® devices—Cellular phone/audio player

For Bluetooth operations, it is required to connect the Bluetooth Adapter (KS-BTA200) to the CD changer jack on the rear.

- Refer also to the instructions supplied with the Bluetooth Adapter and the Bluetooth device.
- Refer to the list (included in the box) to see the countries where you may use the Bluetooth® function.

Menu operation for Bluetooth devices

Registering a Bluetooth device

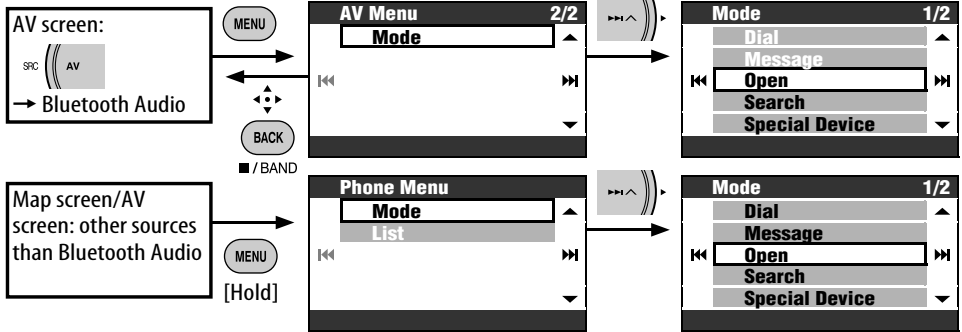

Using the Bluetooth cellular phone

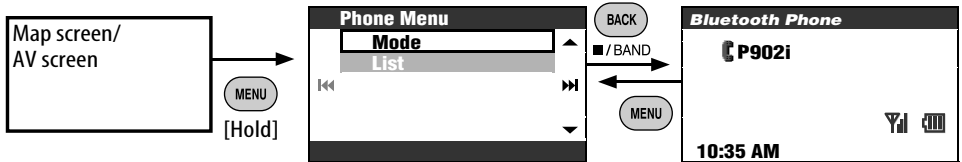

Registering a Bluetooth device

Preparation:

Operate the device to turn on its Bluetooth function.

To use a Bluetooth device through the unit (“Bluetooth Phone” and “Bluetooth Audio”) for the first time, you need to establish Bluetooth wireless connection between the unit and the device.

- Once the connection is established, it is registered in the unit even if you reset your unit. Up to five devices can be registered in total.
- Only one device for Bluetooth Phone and one for Bluetooth Audio can be connected at a time.

Registration (Pairing) methods

- Use **Phone Menu** to register a device as a cellular phone.
- Use **AV Menu** to register a device as an audio player.

Open	Make the unit ready to establish a new Bluetooth connection. Connection is established by operating the Bluetooth device.
Search	Make the unit ready to establish a new Bluetooth connection. Connection is established by operating this unit.

To register another device after you have registered a device, make sure **New Device** is selected. (☞ [85])

Registering using Open

1 Mode

⇒ **Open**

0000		
1	2	3
4	5	6
7	8	9
← BS	0	Connect

2 Enter a PIN (Personal Identification Number)* code to the unit.

- Inputting characters ☞ [105]
- You can enter any number you like (1-digit to 16-digit number).

* Some devices have their own PIN code. Enter the specified PIN code to the unit.

3 Select **Connect**.

Open...

4 Operate the target Bluetooth device.

Enter the same PIN code (as entered in the above step) on the device to be connected.

Now connection is established and you can use the device through the unit.

The device remains registered even after you disconnect the device. Use **Connect** (or activate **Auto Connect**) to connect the same device from next time. (☞ [89])

Searching for available devices

1 Mode

⇒ **Search**

Searching...

The unit searches for available devices and displays the list of them. (If no available device is detected, **Device Unfound** appears.)

2 Select a device you want to connect.

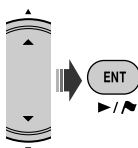

3 Enter the specific PIN code of the device to the unit.

- Inputting characters ☞ [105]
- Refer to the instructions supplied with the device to check the PIN code.

Connecting...

4 Use the Bluetooth device to connect.

Now connection is established and you can use the device through the unit.

Connecting a special device

1 Mode

⇒ **Special Device**

The unit displays the list of the preset devices.

2 Select a device you want to connect.

3 Use **Open** (or **Search**) to connect.

Connecting/disconnecting a registered device

1 On the Bluetooth Phone screen or the Bluetooth Audio screen, select a registered device you want to connect/disconnect.



- Each time you press ▲ ▼, the registered device names (and **New Device** when a new device can be registered) appear in turn.

2 Mode

⇒ **Connect** or
Disconnect

- Select **Connect** to connect the selected device.
- Select **Disconnect** to disconnect the selected device.

You can set the unit to connect a Bluetooth device automatically when the unit is turned on. (☞ [89])

Deleting a registered device

After step **1** above...

Mode

⇒ **Delete Pair**
⇒ **Yes**

- To cancel, select **No**.

Using the Bluetooth cellular phone

Making a call

You can make a call using one of the **Dial** Menu items.

1 Phone Menu

⇒ **Mode**
⇒ **Dial**

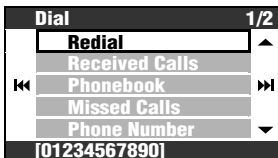

2 Select the method to make a call.

- **Redial**: Shows the list of the phone numbers you have dialed. Go to the following step.
- **Received Calls**: Shows the list of the received calls. Go to the following step.
- **Phonebook**: Shows the phone book of the connected cellular phone. Go to the following step.
- **Missed Calls**: Shows the list of the missed calls. Go to the following step.
- **Phone Number**: Shows the phone number entry screen. → Input numbers and select **Dial**. (Inputting characters ☞ [105])
- **Voice** (Only when the connected cellular phone has the voice recognition system): → Speak the name you want to call.

3 Select the name/phone number you want to call.

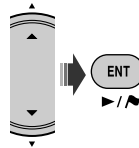

Bluetooth icon lights up when the adapter is connected.^{*1}



Status of the device^{*3}
Signal strength/Battery remainder

*1 Blue: The device is connected.

White: The device is not connected.

*2 Cellular phone

Cellular phone with audio function

*3 Appears only when the information comes from the device.

- You can also access the **Dial** menu by pressing PHONE on the remote controller.
- You can also access the redial list by pressing and holding PHONE on the remote controller.
- You can also access the voice calling screen by pressing and holding MENU while the Bluetooth Phone screen is displayed.

To adjust the volume



- This adjustment does not affect the volume level of the other sources.
- You can adjust the microphone volume level. [89]

To end the call

Press and hold MENU, DISP, BACK, ENT, ▲, ▼, ►/◄, ◀, ▶/◂ or TRAFFIC.

Presetting the phone numbers

You can preset up to six phone numbers.

1 Display the phone number you want to preset by using one of the **Dial** Menu items.

2 Call up the preset list.



[Hold]

- To preset a phone number using **Phone Number**, select **Store** after inputting a phone number.

3 Select a preset number.



To call a preset number

On the remote:

While the Bluetooth Phone screen is displayed...

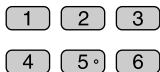

On the unit:

1 Call up the preset list.

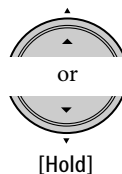

2 Select the preset number to call.

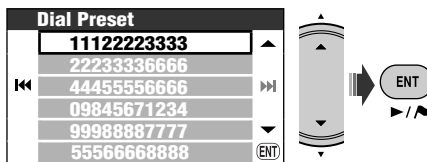

You can also access the preset number list through **Phone Menu** ⇒ **List**.

To dial to the number acquired in Navigation System

1 Search for a POI or a favorite point which has telephone number information.

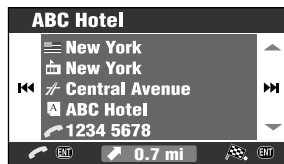

2 Select [Call]



- You cannot make an international call through this function.

You can use the following buttons on the remote controller for the Bluetooth phone operations.

ENT ►/◄, PHONE: Answer the incoming call.

BACK: End the call.

Number keys: Enter the phone number/PIN code.

PHONE: Call up the redial list if pressed and held.

When a call comes in...

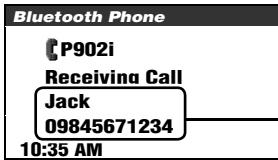

Name and phone number (if acquired)

The screen is automatically changed to Bluetooth Phone.

When Auto Answer is activated

The unit answers the incoming calls automatically. (☞ [89])

- When **Auto Answer** is deactivated, press MENU, DISP, BACK, ENT, ▲, ▼, ►/◄, ◀, ▶/↵ or TRAFFIC to answer the incoming call.

When a text message comes in...

If the cellular phone is compatible with text message and **Message Info** is set to **Auto** (☞ [89]), the unit rings and **Receiving Message** appears on the monitor to inform you of the arrival of the message.

To read the message

While **Receiving Message** is displayed...

ENT

▶/↵

- You cannot edit or send a message through the unit.

Using the Bluetooth audio player

Equalizer type ☞ [98]

Reverse/forward skip

Bluetooth icon: lights up when the adapter is connected.

Stop playback.

- 1 Select "Bluetooth Audio."
- 2 Start playback.

*1 Audio player

*2 Cellular phone with audio function

*3 Each time you press ▲ ▼, the registered device names (and **New Device** when a new device can be registered) appear in turn.

*3 Indicates the button pressed. It may be different from the operation status.

- ☞ [83] for connecting a new device.
- ☞ [85] for connecting/disconnecting a registered device.
- ☞ [85] for deleting a registered device.

You can use the following buttons on the remote controller for the Bluetooth audio operations.

ENT ►/||, BACK: Start/stop playback.

◀◀/▶▶: Reverse/forward skip

VOL +/-: Adjust the volume.

Number keys: Enter the PIN code.

Phone Menu

	Menu items	Selectable settings	(Initial setting)
Dial ¹	Redial	Select a phone number from the list of the phone numbers you have dialed.	
	Received Calls	Select a phone number from the list of the received calls.	
	Phonebook	Select a name, then phone number from the phone book of the connected cellular phone.	
	Missed Calls	Select a phone number from the list of the missed calls.	
	Phone Number	Enter the phone number.	
	Voice	If the connected cellular phone has the voice recognition system, you can call by voice command.	
	Message ²	<p>You can read a message from the following message histories.</p> <p>Unread: Messages you have not read. Read: Messages you have read. Unsent: Messages you have not sent. Sent: Messages you have sent.</p>	
	Open ³	<p>Only for New Device.</p> <p>Make the unit ready to establish a new Bluetooth connection. Select this when establishing a Bluetooth connection with a device for the first time, mainly from the device. ⓘ [84]</p> <ul style="list-style-type: none"> Once the connection is established, it is registered in the unit. You can connect the unit and the device by using Connect (ⓘ [89]) from the next time. 	
	Search ³	<p>Only for New Device.</p> <p>Make the unit ready to establish a new Bluetooth connection. Select this when establishing a Bluetooth connection with a device for the first time, mainly from the unit. The unit searches for available new devices. ⓘ [84]</p> <ul style="list-style-type: none"> Before starting a search, turn on the Bluetooth function of the device so that the unit can detect it. Once the connection is established, it is registered in the unit. You can connect the unit and the device by using Connect (ⓘ [89]) from the next time. 	
	Special Device ³	<p>Only for New Device.</p> <p>Shows the list of Bluetooth devices which requires some special procedure to establish Bluetooth connection. Select a device you want to connect. ⓘ [84]</p> <ul style="list-style-type: none"> After selecting the device, use Open or Search (ⓘ above) for connection. Once the connection is established, it is registered in the unit. You can connect the unit and the device by using Connect (ⓘ [89]) from the next time. 	

Phone Menu (continued)

Menu items		Selectable settings	(Initial setting)
Connect ^{*3}		Only for the registered devices. After selecting a device from among the registered devices (☞ [85, 87]), establish the connection with it. ☞ [85]	
Disconnect ^{*3}		Only for the device being connected. Disconnect the current device before connecting another device. ☞ [85]	
Delete Pair ^{*3}		Only for the registered devices. Delete the registered devices. ☞ [85]	
Setup ^{*3}	Auto Connect	When the unit is turned on, the connection is established automatically with... Off: No Bluetooth device. Last: The last connected Bluetooth device. Order: The available registered Bluetooth device found at first.	
	Auto Answer ^{*4}	Only for the device being connected for “Bluetooth Phone.” Off: The unit does not answer the calls automatically. Answer the call manually. On: The unit answers the incoming calls automatically. Reject: The unit rejects all incoming calls.	
	Message Info ^{*4}	Only for the device being connected for “Bluetooth Phone.” Auto: The unit informs you of the arrival of a message by ringing and displaying Receiving Message . To read the message, press ENT (☞ [87]). Manual: The unit does not inform you of the arrival of a message.	
	Microphone Level ^{*4}	Only for the device being connected for “Bluetooth Phone.” Adjust microphone volume connected to the Bluetooth adapter. 1, 2, 3	
	Version	The Bluetooth software and hardware version is shown.	

*1 Selectable items vary depending on the connected device.

*2 Selectable only when the device is compatible with text message.

*3 Also available in **Mode** in **AV Menu** for Bluetooth Audio.

*4 Not selectable for **New Device**.

Bluetooth Information:

If you wish to receive more information about Bluetooth, visit our JVC web site.

The Bluetooth word mark and logos are owned by the Bluetooth SIG, Inc. and any use of such marks by Victor Company of Japan, Limited (JVC) is under licence. Other trademarks and trade names are those of their respective owners.

AV Menu items

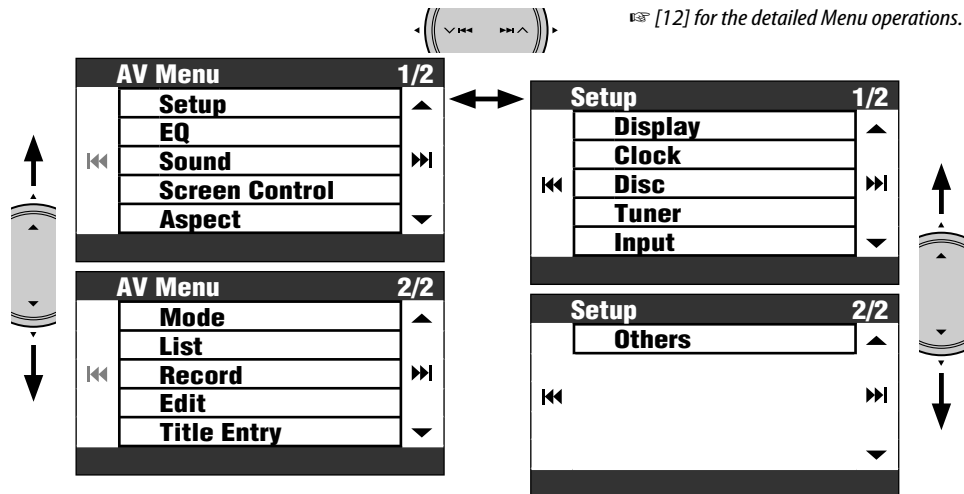

• The menu items shown may vary.

Menu items	Selectable settings (Initial setting)
Language ^{*1}	English US, Español, Français
Wall Paper	You can select the background picture of the monitor. Default, Red, Yellow, Green, Sky, Blue, Purple, Dark-Red, Brown, Dark-Green, Dark-Sky, Dark-Blue
Scroll	Off: Cancels. Once: Scrolls the display information once. Auto: Repeats scrolling (5-second intervals). • Holding DISP scrolls the information regardless of this setting.
Tag Display	Off: Cancels. On: Shows the Tag data while playing MP3/WMA/WAV tracks on discs or on HDD.
Dimmer	Off: Cancels. On: Activates dimmer. Auto: Dims the monitor when you turn on the headlights. ^{*2} Time Set: Set the time to switch the day/night screen. • When you choose Time Set , set the switching time on the following screen.

*1 This setting is shared with the **Language** setting in Setup Menu ([46])

*2 The ILLUMINATION CONTROL lead connection is required. (Installation/Connection Manual)

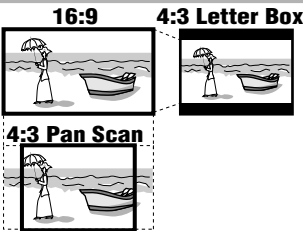
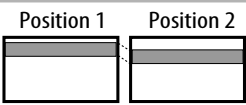
	Menu items	Selectable settings	(Initial setting)	
Setup ↑ Clock	Time Format	12Hours, 24Hours		
	Time Zone	Alaska, Pacific, Mountain, Central, Eastern, Atlantic, Newfoundland		
	DST (Daylight Saving Time)	Activate this if your residential area is subject to DST. Off: Cancels. Auto: Automatically applies DST when necessary.		
Setup ↑ Disc ³	Menu Language^{*4}	Select the initial disc menu language (☞ also [97]). (English)		
	Audio Language^{*4}	Select the initial audio language (☞ also [97]). (English)		
	Subtitle^{*4}	Select the initial subtitle language or erase the subtitle (Off) (☞ also [97]).		
	OSD Language	Select the on-screen language used for the external monitor connected to the VIDEO OUT plug. (English)		
	Monitor Type	Select the monitor type to watch a wide screen picture. 16:9: Select when the aspect ratio of the external monitor is 16:9. 4:3 Letter Box/4:3 Pan Scan: Select when the aspect ratio of the external monitor is 4:3. Refer to the illustrations on the left to see how the pictures are shown on the monitor.		
		 <p>The illustrations show three ways a 4:3 image is displayed on a 16:9 monitor. 1. 16:9: The image is stretched horizontally to fill the width of the monitor. 2. 4:3 Letter Box: The image is shown in its original aspect ratio, with black bars above and below it. 3. 4:3 Pan Scan: The image is shown in its original aspect ratio, but the top and bottom portions are cropped out to fit the width of the monitor.</p>		
	OSD Position	Select the position of the on-screen bar. ☞ [68]		
	 <p>Position 1 shows a horizontal bar at the top of the screen. Position 2 shows a horizontal bar at the bottom of the screen.</p>	1: Higher position 2: Lower position		
	File Type	Select playback file type when a disc contains different types of files. Audio: Plays back audio files. Still Picture: Plays back JPEG files. Video: Plays back DivX/MPEG files.		

*3 Adjustable only while the source is set to DISC and playback is stopped.

*4 After you change these settings, turn off then on the power so that your setting takes effect.

Menu items	Selectable settings (Initial setting)
D. Audio Output	<p>Select the signal format to be emitted through the DIGITAL OUT (Optical) terminal on the rear. For details, see [106].</p> <p>Off: No signal is output from the terminal.</p> <p>PCM Only: Select this when connecting an amplifier or a decoder incompatible with Dolby Digital, DTS or MPEG Audio, or connecting to a recording device.</p> <p>Dolby Digital/PCM: Select this when connecting an amplifier or a decoder compatible with Dolby Digital.</p> <p>Stream/PCM: Select this when connecting an amplifier or a decoder compatible with Dolby Digital, DTS, and MPEG Audio.</p>
Down Mix	<p>When playing back a multi-channel DVD disc, this setting affects the signals reproduced through the LINE OUT jacks (and through the DIGITAL OUT terminal when PCM Only is selected for D. Audio Output).</p> <p>Surround Compat.: Select this when you want to enjoy multichannel surround audio by connecting an amplifier compatible with Dolby Surround to this receiver.</p> <p>Stereo: Normally select this.</p>
D. Range Comp.	<p>You can enjoy a powerful sound at a low volume level while playing Dolby Digital software.</p> <p>Auto: Select to apply the effect to multi-channel encoded software.</p> <p>On: Select to always use this function.</p>
DivX Registration	<p>This unit has its own Registration Code. Once you have played back a disc in which the Registration Code recorded, this unit's Registration Code is overwritten for copyright protection.</p>
Video Output Format	<p>Select the format of video output according to the color system of your external monitor.</p> <ul style="list-style-type: none"> The color system of the unit's display is also changed. Picture quality on the main unit's display may deteriorate when you select PAL. <p>NTSC, PAL</p>





	Menu items	Selectable settings (Initial setting)
Setup ↑ Tuner	IF Band Width	Auto: Increases the tuner selectivity to reduce interference noises between adjacent stations. (Stereo effect may be lost.) Wide: Subject to the interference from adjacent stations, but sound quality will not be degraded and the stereo effect will remain.
	Area Setting	US: When using in North/Central/South America. AM/FM intervals are set to 10 kHz/200 kHz. Europe: When using in any other areas. AM/FM intervals are set to 9 kHz/50 kHz (100 kHz during auto search). South America: When using in South American countries where FM interval is 100 kHz. AM interval is set to 10 kHz.
	SIRIUS ID^{*5}	Your SIRIUS identification number appears on the monitor.
Setup ↑ Input	External Input^{*6}	When connecting an external component to the CD changer jack on the rear. Changer: CD changer, iPod, or D. player. Ext Input: Any other than the above. <ul style="list-style-type: none">• For connecting the satellite radio tuner or the Bluetooth Adapter, this setting is not required. It is automatically detected.
	Video Input^{*7}	You can determine the use of the VIDEO IN plug. [82] Off: Select if no component is connected. (Video input is skipped while changing the display with DISP key.) Video: Select when connecting an AV component such as VCR. Camera: Select when connecting a camera.

**5 Appears only when a SIRIUS tuner is connected.*

**6 Not selectable when the component connected to the CD changer jack is selected as the source.*

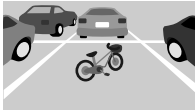
**7 Not selectable when "EXT-IN" is selected as the source.*

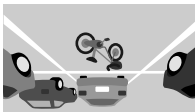
		Menu items	Selectable settings	(Initial setting)		
Setup ↑ Input	For Camera	Interlock	Off: Cancels. Reverse: Automatically switch to the camera view when the gear is shifted into reverse.* ⁸ Low Speed: Automatically switch to the camera view when your car slows down.* ⁹			
		Horizontal/ Vertical	Horizontal adjustment is required according to how you would like to see the picture on the monitor. Vertical adjustment is required according to how you have installed your camera.		Horizontal: Normal	Horizontal: Reverse
				Vertical: Normal		
					Vertical: Reverse	
				Video Format * ¹⁰		Select the format of video input according to the color system of the component connected to the VIDEO IN plug. NTSC, PAL
Setup ↑ Others	Beep	Off: Cancels. On: Activates the key-touch tone.				
	Telephone Muting	You can mute the sound of the System (AV source sounds and voice guidance) while you talk on the cellular phone. Off: Cancels. Muting1, Muting2: Select either one which mute the sounds while using the cellular phone.* ¹¹				
	Reverse Polarization	Select either of the two which indicates your gear direction correctly. GND, Battery				
	Connection * ¹²	You can check the connection status.				

*⁸ Reverse lamp lead connection is required. (☞ Installation/Connection Manual)

*⁹ Speed signal lead connection is required. (☞ Installation/Connection Manual)

*¹⁰ Not selectable when **Video Input** is set to **Off**.

*¹¹ The TEL MUTING lead connection is required. (☞ Installation/Connection Manual)

*¹² This shows the same information as **Connection** in the Information Menu (☞ [43]).

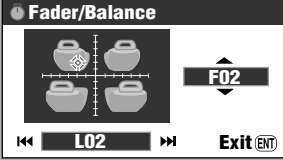
Menu items	Selectable settings (Initial setting)
EQ	Flat, Hard Rock, R&B, Pop, Jazz, Dance Music, Country, Reggae, Classic, User 1, User 2, User 3 <small>[98]</small>
Fader/Balance 	Adjust fader—speaker output balance between the front and rear speakers. (00) F06: front only R06: rear only <ul style="list-style-type: none"> When using a two-speaker system, set the fader to the center (00). Adjust balance—speaker output balance between the left and right speakers. (00) L06: left only R06: right only
Sound	Volume Adjust Adjust and store auto-adjustment volume level for each source, comparing to the FM volume level. The volume level will automatically increase or decrease when you change the source. -12 to +12 (00)
	Subwoofer Adjust the settings below in the submenu: <ul style="list-style-type: none"> Phase: Subwoofer phase. Select either Normal or Reverse, which reproduces a better sound. Level: Subwoofer output level. 00 to 08 (04)
	High Pass Filter Through: Select when the subwoofer is not connected. On: Select when the subwoofer is connected.
	Crossover Adjust the crossover frequency between the front/rear speakers and the subwoofer. 55 Hz, 85 Hz, 125 Hz
	Amplifier Gain You can change the maximum volume level of this receiver. Amplifier Off: Deactivates the built-in amplifier. Low Power: Volume 00 to 30 (Select this if the maximum power of the speakers is less than 50 W) High Power: Volume 00 to 50

Menu items

Selectable settings

(Initial setting)

Screen Control/
Picture [Disc]/
Picture [Video]

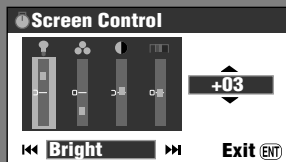

You can adjust the monitor to make it clear and legible.

- While picture from VIDEO IN is displayed, you can adjust the playback picture of VIDEO IN (**Picture [Video]**).
- While DISC is selected as the source and playback picture is displayed, you can adjust the playback picture of DISC (**Picture [Disc]**).
- For other screens than above, **Screen Control** appears.*13

Bright*14: Adjust if the picture is too bright or too dark. **-15 to +15 (00)**

Color Temp.: Adjust the color temperature of the picture—warmer or cooler. **-15 to +15 (00)**

Contrast: Adjust the contrast. **-15 to +15 (00)**

Tint: Adjust the tint if the human skin color is unnatural. **-15 to +15 (00)**

- **Tint** is adjustable only for VIDEO IN signal in NTSC and discs in NTSC.

Aspect [Disc]/
Aspect [Video]

You can change the aspect ratio of the picture.

	Aspect ratio of incoming signal	
	4:3	16:9
Full: For 16:9 original pictures		
Regular: For 4:3 original pictures		
Auto:	<ul style="list-style-type: none"> • For “DISC”: Aspect ratio is automatically selected to match to the incoming signals. • For the other video sources: Aspect ratio is fixed to Full. 	

*13 The settings of **Screen Control** are also applied to the map screen and screens of Navigation Menus.

*14 This setting in **Screen Control** is shared with **Brightness** setting in **Setup** Menu (☰ [44]).

	Menu items	Selectable settings	(Initial setting)
Mode ¹⁵	Mono	Only for FM. (Off, On) [54]	
	DX / Local	Only for FM. (DX, Local) [54]	
	SSM	Only for FM. [52]	
	Intro/Repeat/Random	Only for disc playback, music server, CD changer and iPod/D. player. [64, 71, 78, 80]	
List	The accessible lists differ depending on the sources.		
Record	To record audio CDs into the music server. [72, 73]		
Copy	To copy music files into the music server. [74]		
Edit	To edit the tracks in the music server. [75]		
Title Entry	[54, 75, 81]		

*15 For the menu items in **Mode** for Bluetooth Audio, [88, 89].

Language codes (for DVD/DivX language selection)

Code	Language	Code	Language	Code	Language	Code	Language	Code	Language
AA	Afar	FA	Persian	KL	Greenlandic	OC	Occitan	ST	Sesotho
AB	Abkhazian	FI	Finnish	KM	Cambodian	OM	(Afan) Oromo	SU	Sundanese
AF	Afrikaans	FJ	Fiji	KN	Kannada	OR	Oriya	SW	Swahili
AM	Ameharic	FO	Faroese	KO	Korean (KOR)	PA	Panjabi	TA	Tamil
AR	Arabic	FY	Frisian	KS	Kashmiri	PL	Polish	TE	Telugu
AS	Assamese	GA	Irish	KU	Kurdish	PS	Pashto, Pushto	TG	Tajik
AY	Aymara	GD	Scots Gaelic	KY	Kirghiz	PT	Portuguese	TH	Thai
AZ	Azerbaijani	GL	Galician	LA	Latin	QU	Quechua	TI	Tigrinya
BA	Bashkir	GN	Guarani	LN	Lingala	RM	Rhaeto-Romance	TK	Turkmen
BE	Byelorussian	GU	Gujarati	LO	Laothian	RN	Kirundi	TL	Tagalog
BG	Bulgarian	HA	Hausa	LT	Lithuanian	RO	Rumanian	TN	Setswana
BH	Bihari	HI	Hindi	LV	Latvian, Lettish	RW	Kinyarwanda	TO	Tonga
BI	Bislama	HR	Croatian	MG	Malagasy	SA	Sanskrit	TR	Turkish
BN	Bengali, Bangla	HU	Hungarian	MI	Maori	SD	Sindhi	TS	Tsonga
BO	Tibetan	HY	Armenian	MK	Macedonian	SG	Sangho	TT	Tatar
BR	Breton	IA	Interlingua	ML	Malayalam	SH	Serbo-Croatian	TW	Twi
CA	Catalan	IE	Interlingue	MN	Mongolian	SI	Singhalese	UK	Ukrainian
CO	Corsican	IK	Inupiak	MO	Moldavian	SK	Slovak	UR	Urdu
CS	Czech	IN	Indonesian	MR	Marathi	SL	Slovenian	UZ	Uzbek
CY	Welsh	IS	Icelandic	MS	Malay (MAY)	SM	Samoan	VI	Vietnamese
DZ	Bhutani	IW	Hebrew	MT	Maltese	SN	Shona	VO	Volapuk
EL	Greek	JI	Yiddish	MY	Burmese	SO	Somali	WO	Wolof
EO	Esperanto	JW	Javanese	NA	Nauru	SQ	Albanian	XH	Xhosa
ET	Estonian	KA	Georgian	NE	Nepali	SR	Serbian	YO	Yoruba
EU	Basque	KK	Kazakh	NO	Norwegian	SS	Siswati	ZU	Zulu

Sound equalization

Selecting an equalizer type

1 

2 AV Menu
⇒ EQ

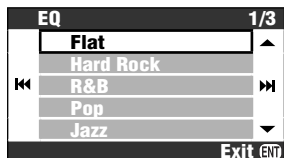

3 Select an equalizer type.

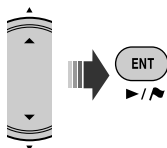

Preset equalizing values

Equalizer type	60 Hz	150 Hz	400 Hz	1 kHz	2.4 kHz	6 kHz	12 kHz
Flat	00	00	00	00	00	00	00
Hard Rock	+03	+03	+01	00	00	+02	+01
R&B	+03	+02	+02	00	+01	+01	+03
Pop	00	+02	00	00	+01	+01	+02
Jazz	+03	+02	+01	+01	+01	+03	+02
Dance Music	+04	+02	00	-02	-01	+01	+01
Country	+02	+01	00	00	00	+01	+02
Reggae	+03	00	00	+01	+02	+02	+03
Classic	+02	+03	+01	00	00	+02	00
User 1/2/3	00	00	00	00	00	00	00

Storing your own adjustment

You can store your adjustment into **User 1**, **User 2**, and **User 3**.

1 Repeat steps 1 and 2 above, then in step 3...

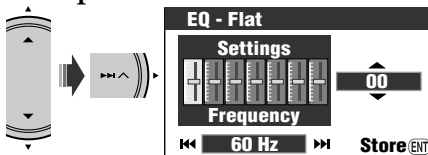

2 Adjust.

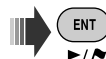
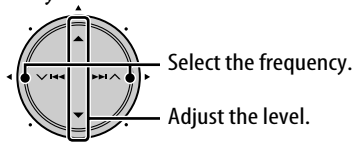

3 Store the setting into **User 1**, **User 2** or **User 3**.

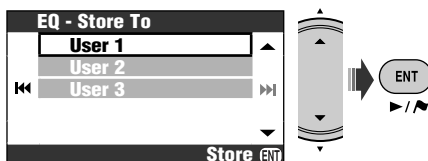

Additional Information

General

- There is a time limit for some operations. In this case, if no further operation is done for a certain period, the current operation is canceled.
- By pressing SRC or MAP on the unit, you can also turn on the power. The map screen is displayed at turn-on if you press MAP, and an AV screen if you press SRC. If the source is ready, playback starts.
- You cannot select some sources if they are not ready.
 - SAT/CD-CH/iPod/D. PLAYER: cannot be selected without connecting the target source component.
 - DISC: cannot be selected if a disc is not in the loading slot.
 - EXT-IN: cannot be selected without selecting **Ext Input** for the **External Input** setting. (☞ [93])
 - Bluetooth Audio: cannot be selected if a Bluetooth adapter is not connected.
- If you turn off the power while DISC is selected as the source, disc play will start automatically next time you turn on the power.
- The voltage and the speed on the vehicle information screen may be different from the actual values.

Listening to the radio

Storing stations in memory

- When SSM is over, all previously stored stations are erased and stations are stored newly.
- When SSM is over, received stations are preset in No. 1 (lowest frequency) to No. 6 (highest frequency), and preset station No. 1 is tuned in.
- When storing a station manually, a previously preset station is erased when a new station is stored in the same preset number.

Satellite radio operations

- You can also connect the JVC SIRIUS radio PnP (Plug and Play), using the JVC SIRIUS radio adapter, KS-U100K (not supplied) to the CD changer jack on the rear. By turning on/off the power of the unit, you can turn on/off the JVC PnP. However, you cannot control it from this unit.
- To know more about SIRIUS Satellite radio or to sign up, visit <<http://www.sirius.com>>.
- For the latest channel listings and programming information, or to sign up for XM Satellite radio, visit <<http://www.xmradio.com>>.

Disc operations

General

- In this manual, words “track” and “file” are interchangeably used.
- This unit can also play back 8 cm discs.
- This unit can only play back audio CD (CD-DA) files if different type of files are recorded in the same disc.
- On some discs, the actual operations may be different from what is explained in this manual.
- This unit can display only one-byte characters. No other characters can be correctly displayed.
- Reverse search stops automatically when it reaches the beginning of the disc. Playback resumes at normal speed.
- No sound comes out during slow motion playback. When playing a VCD, reverse slow motion playback is prohibited.
- When playing a DVD/VCD, no sound comes out during Search.
- For some DVDs and VCDs, changing the subtitle language, audio language (or audio channel) without using the disc menu is prohibited.

Inserting a disc

- When a disc is inserted upside down, **Disc Error** appears on the monitor. Eject the disc.

Ejecting a disc

- If the ejected disc is not removed within 15 seconds, the disc is automatically inserted again into the loading slot to protect it from dust.
- If the control panel is left open for a while, it closes automatically.

Changing the source

- If you change the source, playback also stops without ejecting the disc.
Next time you select “DISC” for the playback source, disc play starts from where it has been stopped previously.
- When a disc has been loaded, selecting “DISC” for the playback source starts disc play.

Playing Recordable/Rewritable discs

- This unit can recognize a total of 3 500 files and 250 folders (a maximum of 999 files per folder).
- If no playable files are recorded in a folder, the folder will not be recognized.
- Use only “finalized” discs.
- This unit can play back multi-session discs; however, unclosed sessions will be skipped while playing.
- This unit may be unable to play back some discs or files due to their characteristics or recording conditions.
- This unit can recognize a total 25 characters for file/folder names.
- For DVD-R/DVD-RW: This receiver can play only discs recorded in the DVD-Video format. (Discs recorded in the DVD-VR format cannot be played.)
- DVD-RWs or CD-RWs may require a longer readout time since the reflectance of DVD-RW and CD-RW is lower than that of regular discs.
- Do not use discs on which labels can be directly printed by an ink jet printer. Using these discs under high temperatures or high humidity may cause malfunctions or damages to discs.

Playing DivX files

- This unit can play back DivX files with the extension code <.divx>, <.div>, <.avi> (regardless of the letter case—upper/lower).
- This unit supports the DivX files whose resolution is 720 x 576 pixels or less.
- This unit supports DivX 6.x, 5.x, 4.x, and 3.11.
- Audio stream should conform to MP3 or Dolby Digital.
- This unit does not support GMC (Global Motion Compression).
- The file encoded in the interlaced scanning mode may not be played back correctly.
- This unit can display a unique registration code—DivX Video On Demand (DRM—Digital Rights Management). For activation and more detail, visit <www.divx.com/vod>.

Playing MPEG files

- This unit can play back MPEG files with the extension code <.mpg> or <.mpeg>.
- The stream format should conform to MPEG system/program stream.
- The file format should be MP@ML (Main Profile at Main Level)/SP@ML (Simple Profile at Main Level)/MP@LL (Main Profile at Low Level).
- Audio streams should conform to MPEG1 Audio Layer-2.

Playing JPEG files

- It is recommended that you record a file at 640 x 480 resolution.
- This unit can play back baseline JPEG files. Progressive JPEG files or lossless JPEG files cannot be played.

Playing MP3/WMA/WAV files

- This unit can play back files with the extension code <.mp3>, <.wma>, or <.wav> (regardless of the letter case—upper/lower).
- This unit can show ID3 Tag Version 1.0/1.1/2.2/2.3/2.4 (for MP3). This unit can also show WAV Tag and WMA Tag.
- This unit can play back the files meeting the conditions below:
 - Bit rate: MP3/WMA: 32 kbps - 320 kbps
 - Sampling frequency:
 - 48 kHz, 44.1 kHz, 32 kHz (for MPEG1)
 - 24 kHz, 22.05 kHz, 16 kHz (for MPEG2)
 - 48 kHz, 44.1 kHz, 32 kHz (for WMA)
 - 44.1 kHz (for WAV)
 - Disc format: ISO 9660 Level 1/ Level 2, Romeo, Joliet, Windows long file name

- This unit can play back files recorded in VBR (variable bit rate). Files recorded in VBR have a discrepancy in elapsed time indication.
- This unit cannot play back the following files and skips them when playing back files:
 - MP3 files encoded with MP3i and MP3 PRO format.
 - MP3 files encoded in an unappropriated format.
 - MP3 files encoded with Layer 1/2.
 - WMA files encoded with lossless, professional, and voice format.
 - WMA files which are not based upon Windows Media® Audio.
 - WMA DRM (Digital Rights Management).
 - Files which have the data such as AIFF, ATRAC3, etc.
 - WMA files encoded with MBR (Multiple Bit Rate) format.
 - AAC files.
 - OGG files.



On-screen guide icons

During play, the following guide icons may appear for a while on the monitor.



Appears at the beginning of a scene containing multi-subtitle languages (for DVD only).



Appears at the beginning of a scene containing multi-audio languages (for DVD only).



Appears at the beginning of a scene containing multi-angle views (for DVD only).



Playback



Pause



Forward slow motion playback (for DVD and VCD only)



Reverse slow motion playback (for DVD only)



Forward search



Reverse search

Control screen

- The following control screens appear only on the external monitor.

DivX/MPEG/JPEG/MP3/WMA/WAV

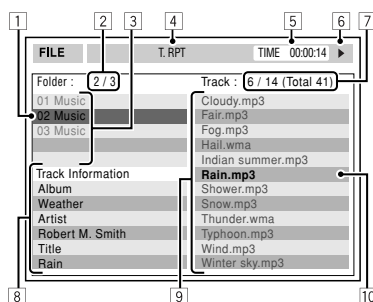

- Current folder (highlighted bar)
- Current folder number/total folder number
- Folder list
- Selected playback mode
- Elapsed playing time of the current track (not displayed for JPEG)
- Operation status
- Current track number/total number of tracks in the current folder (total number of tracks on the disc)
- Track information (only for MP3/WMA/WAV)
- Track list
- Current track (highlighted)

CD

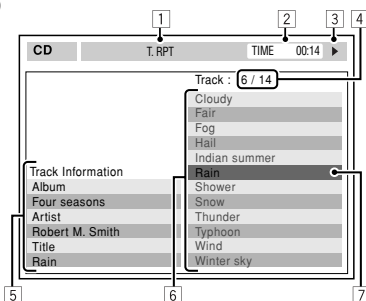

- Selected playback mode
- Elapsed playing time of the current track
- Operation status
- Current track number/total number of tracks on the disc
- Track information
- Track list
- Current track (highlighted bar)

Music server operations

- Sound quality may deteriorate if you select **Normal Quality** for recording mode.
- While recording, recorded sounds are reproduced from the speakers. When recording is stopped, CD original sounds are reproduced.
- You cannot change the source while recording or copying tracks.
- This system uses SCMS (Serial Copy Management System) which allows only first-generation digital copies to be made of mastered software such as regular CDs. If you try to record from a duplicated CD-R/-RW, **SCMS Cannot Copy** may appear on the display then recording will be cancelled.
- Text data in the CD Text cannot be recorded into the HDD.
- Play time indication may advance unstably on the monitor while recording. This is not a malfunction of this unit.
- You cannot edit the Tag data of tracks in the HDD.
- While the System is moving, rearranging or deleting items in the library, no sound comes out, and you cannot change the playback source.
- When you move, rearrange or delete items in the library, the playback mode is canceled.

iPod/D. player operations

- When you turn on this unit, the iPod or D. player is charged through this unit.
- The text information may not be displayed correctly. This unit can display up to 40 characters.
- The items in the player's top menu are as follows:
 - For iPod:**
Playlists ↔ Artists ↔ Albums ↔ Songs
↔ Genres ↔ Composers ↔ (back to the beginning)
 - For D. player:**
Playlist ↔ Artist ↔ Album ↔ Genre
↔ Track ↔ (back to the beginning)

Notice:

When operating an iPod or a D. player, some operations may not be performed correctly or as intended. In this case, visit the following JVC web site:

For iPod users: <<http://www.jvc.co.jp/english/car/support/ks-pd100/index.html>>

For D. player users: <<http://www.jvc.co.jp/english/car/support/ks-pd500/index.html>>

Using Bluetooth devices

General

- While driving, do not perform complicated operation such as dialing the numbers, using phone book, etc. When you perform these operations, stop your car in a safe place.
- Some Bluetooth devices may not be connected to this unit depending on the Bluetooth version of the device.
- This unit may not work for some Bluetooth devices.
- Connecting condition may vary depending on circumstances around you.
- When the unit is turned off, the device is disconnected.

Icons for phone types

- These icons indicate the phone type set on the device.



: Cellular phone



: Household phone



: Office



: General



: Other than above

Warning messages for Bluetooth operations

- **Connection Error** : The device is registered but the connection has failed. Use **Connect** to connect the device again. (☞ [85])
- **Error** : Try the operation again. If **Error** appears again, check if the device supports the function you have tried.
- **Device Unfound** : No available Bluetooth device is detected by **Search**.
- **Loading** : The unit is updating the phone book and/or a text message.
- **Please Wait...** : The unit is preparing to use the Bluetooth function. If the message does not disappear, turn off and turn on the unit, then connect the device again (or reset the unit).
- **Reset 08** : Check the connection between the adapter and this unit.

AV Menu items

- If you change the **Amplifier Gain** setting from **High Power** to **Low Power** while the volume level is set higher than **30**, the unit automatically changes the volume level to **Volume 30**.
- After you change any of **Menu Language/Audio Language/Subtitle** settings, turn off then on the power, and re-insert the disc (or insert another disc) so that your setting takes effect.
- When the language you have selected is not recorded on a disc, the original language is automatically used as the initial language. In addition, for some discs, the initial languages settings will not work as you set due to their internal disc programming.
- When you select **16:9** for a picture whose aspect ratio is 4:3, the picture slightly changes due to the process for converting the picture width.
- Even if **4:3 Pan Scan** is selected, the screen size may become **4:3 Letter Box** for some discs.

Inputting characters

Ex.:

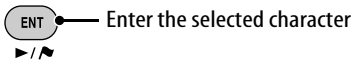
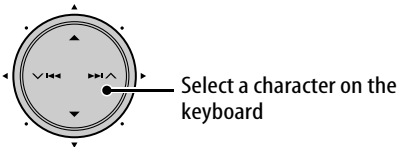
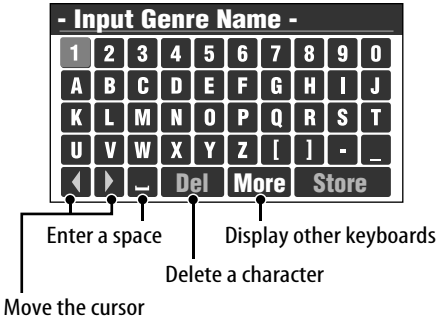

To display other keyboards



- Each time you press the button, the keyboard changes cyclically. By pressing and holding the button, you can change the keyboards in the reverse direction.

To delete all the characters

Select **Del** and hold ENT.

- While driving at a speed greater than 6 mi/h (10 km/h), operations of inputting are prohibited.

Checkbox operations

Ex.:

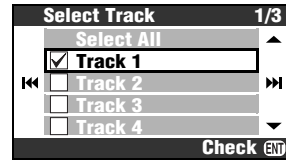

To select an item in the list

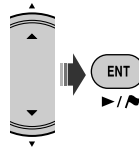

- Each time you press ENT, the checkbox alternates between checked (selected) and not checked (not selected).

To select all the items in the list

Select **Select All** and press ENT.

- When you have selected all the items, the top item in the list changes to **Deselect All**. To remove all the item from selection, select **Deselect All** and press ENT.

Characters available for word entry

In addition to the roman alphabet (A – Z, a – z), the following characters can be used to input various information.

á	à	â	ä	ã	â	æ	œ	č	ć	ç	é
è	ê	ë	ě	ğ	í	ì	î	ï	ñ	ň	ń
ó	ò	ô	ö	õ	ø	ő	ř	í	š	ś	ş
ú	ù	û	ü	ú	w	y	ý	ž	z	ÿ	þ
ŋ	đ	ț	ı	ı	ij	ß	ö	space			

Á	À	Â	Ä	Ã	Â	Æ	Œ	Č	Ć	Ç	É
È	Ê	Ë	Ě	Ğ	Í	Ì	Î	Ï	Ñ	Ń	Ň
Ö	Õ	Ø	Ő	Ř	Í	Š	Ś	Ş	Ú	Ù	Û
Ý	Ž	Ž	ı	ı	ı	ı	ı	ı	ı	ı	ı

1	2	3	4	5	6	7	8	9	0	-	,
!	@	"	#	\$	%	&	*	+	,	.	/
:	;	<	=	>	?	i	ı	£	`	€	α

About sounds reproduced through the rear terminals

- Through the analog terminals (Speaker out/LINE OUT):
2-channel signal is emitted. When playing a multi-channel encoded disc, multi-channel signals are downmixed. (ⓘ [92] **Down Mix**.)
- Through DIGITAL OUT (optical):
Digital signals (Linear PCM, Dolby Digital, DTS, MPEG Audio) are emitted through this terminal. To reproduce multi-channel sounds such as Dolby Digital, DTS, and MPEG Audio, connect an amplifier or a decoder compatible with these multi-channel sources to this terminal, and set **D. Audio Output** correctly. (ⓘ below.)

Output signals through the DIGITAL OUT terminal

Output signals are different depending on the **D. Audio Output** setting (ⓘ [92]).

D. Audio Output		PCM Only		Dolby Digital/PCM		Stream/PCM	
		<i>Playback disc</i>					
DVD Video	48 kHz, 16/20/24 bits Linear PCM		48 kHz, 16 bits stereo Linear PCM*				
	96 kHz, Linear PCM		48 kHz, 16 bits stereo Linear PCM				
	with Dolby Digital		48 kHz, 16 bits stereo Linear PCM		Dolby Digital bitstream		
	with DTS		48 kHz, 16 bits stereo Linear PCM			DTS bitstream	
	with MPEG Audio		48 kHz, 16 bits stereo Linear PCM			MPEG bitstream	
DVD Audio	44.1/88.2/176.4 kHz, 16/20/24 bits Linear PCM		44.1 kHz, 16 bits stereo Linear PCM				
	48/96/192 kHz, 16/20/24 bits Linear PCM		48 kHz, 16 bits stereo Linear PCM				
	with Dolby Digital		48 kHz, 16 bits stereo Linear PCM		Dolby Digital bitstream		
	with DTS		48 kHz, 16 bits stereo Linear PCM			DTS bitstream	
Audio CD, Video CD		44.1 kHz, 16 bits stereo Linear PCM 48 kHz, 16 bits stereo Linear PCM					
Audio CD with DTS		48 kHz, 16 bits stereo Linear PCM			DTS bitstream		
DivX	with Dolby Digital		48 kHz, 16 bits stereo Linear PCM		Dolby Digital bitstream		
	with MPEG Audio		32/44.1/48 kHz, 16 bits Linear PCM				
MPEG		44.1/48 kHz, 16 bits Linear PCM					
MP3/WMA		32/44.1/48 kHz, 16 bits Linear PCM					
WAV		44.1 kHz, 16 bits stereo Linear PCM					

* While playing some DVDs, digital signals may be emitted at 20 bits or 24 bits (at their original bit rate) through the DIGITAL OUT terminal if the discs are not copy-protected.

Information

108 Maintenance

109 Troubleshooting

117 Specifications



Maintenance

How to clean the connectors

Frequent detachment will deteriorate the connectors.

To minimize this possibility, periodically wipe the connectors with a cotton swab or cloth moistened with alcohol, being careful not to damage the connectors.

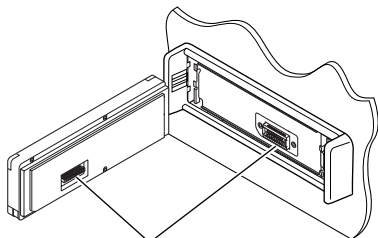

Connectors

Moisture condensation

Moisture may condense on the lens inside the DVD/CD player in the following cases:

- After starting the heater in the car.
- If it becomes very humid inside the car.

Should this occur, the DVD/CD player may malfunction. In this case, eject the disc and leave the unit turned on for a few hours until the moisture evaporates.

To clean the unit

When the unit is very dirty, wipe with a well-wrung cloth dipped in a kitchen cleanser (neutral) thinned by water and then go over the same surface with a dry cloth.

(Since there is the possibility of water drops getting inside of the unit, do not directly apply cleanser to the surface.)

How to handle discs

When removing a disc from its case, press down the center holder of the case and lift the disc out, holding it by the edges.



- Always hold the disc by the edges. Do not touch its recording surface.

When storing a disc into its case, gently insert the disc around the center holder (with the printed surface facing up).

- Make sure to store discs into the cases after use.

To keep discs clean

A dirty disc may not play correctly. If a disc does become dirty, wipe it with a soft cloth in a straight line from center to edge.



- Do not use any solvent (for example, conventional record cleaner, spray, thinner, benzine, etc.) to clean discs.

To play new discs

New discs may have some rough spots around the inner and outer edges. If such a disc is used, this unit may reject the disc.



To remove these rough spots, rub the edges with a pencil or ball-point pen, etc.

Do not use the following discs:

Warped disc



Sticker



Sticker residue



Stick-on label

Troubleshooting

What appears to be trouble is not always serious. Check the following points before calling a service center.



	Symptoms	Causes/Remedies
General	<ul style="list-style-type: none"> • Parking Brake appears on the monitor. 	Some operations are prohibited without the parking brake engaged. Park the car in a safe place before the operations.
	<ul style="list-style-type: none"> • Sound cannot be heard from the speakers. 	<ul style="list-style-type: none"> • Adjust the volume to the optimum level. • Check the cords and connections.
	<ul style="list-style-type: none"> • The monitor is not clear and legible for watching the playback picture or the map. 	Sunshine from the windshield may cause this symptom. Adjust Bright and Contrast of Screen Control . (☞ [96]).
	<ul style="list-style-type: none"> • Low Temperature/HDD Warming Up appears and some functions do not work properly. 	The internal temperature is too low. Leave the power on, and wait until the internal temperature rises and the indication goes off.
	<ul style="list-style-type: none"> • Push Reset appears on the display, and the control panel movement is frozen. 	Something is blocking the control panel movement. Remove the obstacle, then reset the unit (☞ [4]). <ul style="list-style-type: none"> • If this does not work, check if the installation has been correctly done.
Navigation	<ul style="list-style-type: none"> • The unit does not work at all. 	Reset the unit (☞ [4]).
	<ul style="list-style-type: none"> • Cannot operate some functions of an AV source on the map screen. 	On the map screen, you can operate only some limited functions of the current source. Press SRC to display the AV screen and operate the source.
	<ul style="list-style-type: none"> • Cannot operate AV sources with the remote controller on the map screen. 	On the map screen, ◀◀▶▶ ▲▼ keys of the remote controller always works for scrolling the map.
	<ul style="list-style-type: none"> • Route calculation seems to have stopped. 	Route calculation may take long depending on the route. Wait for a while.
	<ul style="list-style-type: none"> • Navigation voice cannot be heard from the speakers. 	Guidance voice level is set to the minimum level. Adjust it to the optimum level. (☞ [43])
	<ul style="list-style-type: none"> • Voice guidance are not heard while viewing an AV screen. 	Interruption is set to Off . Set it to On to allow the voice guidance interrupt the AV source. (☞ [44])
Navigation	<ul style="list-style-type: none"> • The voice guidance does not come out from the speaker on the driver's side. 	Change the Output Channel setting. (☞ [43])
	<ul style="list-style-type: none"> • Cannot scroll the map to northeast, etc. 	To scroll to northeast, you need to press ▲ and ▶▶ at the same time.

	Symptoms	Causes/Remedies
Navigation	<ul style="list-style-type: none"> • Navigation guidance is incorrect. 	Installation angle setting is not correct. Set it correctly. (☞ [46])
	<ul style="list-style-type: none"> • Navigation guidance is sometimes incorrect. 	Reversing signal/speed signal wires are not connected. Connect them correctly (☞ Installation/Connection Manual—separate volume).
	<ul style="list-style-type: none"> • Navigation guidance is hard to listen to. 	Surround noise interferes. Increase the voice cruise level. (☞ [44])
	<ul style="list-style-type: none"> • Route Calculation Error. appears on the monitor. 	Failed to calculate the route. Select another destination/via point.
	<ul style="list-style-type: none"> • City not found., Street/Center not found., Valid information not found., Coordinate information not found. or Street not found. appears on the monitor. 	Valid information is not available in the database. Search for another place.
	<ul style="list-style-type: none"> • A POI found using Category in the Destination Menu is not within the selected city/state. 	This is not a malfunction. The system may also search areas around the selected city/state.
	<ul style="list-style-type: none"> • The route name already exists. appears on the monitor. 	You tried to save a route in an existing name. Select another name.
	<ul style="list-style-type: none"> • No space to store the new route. appears on the monitor. 	Delete some routes and save the new one.
	<ul style="list-style-type: none"> • There are no valid traffic information. appears on the monitor. 	No valid traffic information is available now.
<ul style="list-style-type: none"> • The current position displayed on the map remains wrong for more than 30 minutes. 	<p>Check the connection information of the leads below. (☞ [43] Connection)</p> <ul style="list-style-type: none"> – GPS antenna – Speed signal lead – Reverse gear signal lead <p>If any disconnection is found, connect the lead again.</p> <ul style="list-style-type: none"> • If no problems are found with connections, reset the calibration data. (☞ [46] Reset Calibration) 	



	Symptoms	Causes/Remedies
FM/AM	<ul style="list-style-type: none"> • SSM automatic presetting does not work. 	Store stations manually (☞ [53]).
	<ul style="list-style-type: none"> • Static noise while listening to the radio. 	Connect the antenna firmly.
Satellite radio	<ul style="list-style-type: none"> • CALL 1-888-539-SIRIUS TO SUBSCRIBE appears on the monitor. 	Start subscribing to SIRIUS Satellite Radio (☞ [55]).
	<ul style="list-style-type: none"> • No Signal or NO SIGNAL appears on the monitor. 	Move to an area where signals are stronger.
	<ul style="list-style-type: none"> • No Antenna or CHECK ANTENNA appears on the monitor. 	Connect the antenna firmly.
	<ul style="list-style-type: none"> • Invalid Channel appears on the monitor for about 5 seconds, then returns to the previous display when listening to the SIRIUS Satellite radio. 	No broadcast on the selected channel. Select another channel or continue listening to the previous channel.
	<ul style="list-style-type: none"> • CHANNEL--- appears on the display for about 2 seconds, then returns to the previous channel while listening to the XM Satellite radio. 	Selected channel is no longer available or is unauthorized. Select another channel or continue listening to the previous channel.
	<ul style="list-style-type: none"> • NO NAME appears on the monitor. 	No text information for the selected channel.
	<ul style="list-style-type: none"> • Channels Updating XX% completed (for SIRIUS) or UPDATING (for XM) appear on the monitor. 	The unit is updating the channel information and it takes a few minutes to complete.
	<ul style="list-style-type: none"> • OFF AIR appears on the display while listening to the XM Satellite Radio. 	Selected channel is not broadcasting at this time. Select another channel or continue listening to the previous channel.
	<ul style="list-style-type: none"> • LOADING appears on the display while listening to the XM Satellite Radio. 	The unit is loading the channel information and audio. Text information are temporarily unavailable.
	<ul style="list-style-type: none"> • Reset 08 appears on the display. 	Reconnect this unit and the Satellite Radio correctly and reset this unit.
Disc playback	<ul style="list-style-type: none"> • Satellite Radio does not work at all. 	Reconnect the Satellite radio after a few seconds.
	<ul style="list-style-type: none"> • Disc can be neither recognized nor played. 	Eject the disc forcibly (☞ [4]).
	<ul style="list-style-type: none"> • Disc cannot be ejected. 	Unlock the disc (☞ [65]).
	<ul style="list-style-type: none"> • Recordable/Rewritable discs cannot be played back. 	<ul style="list-style-type: none"> • Insert a finalized disc. • Finalize the discs with the component which you used for recording.
	<ul style="list-style-type: none"> • Tracks on the Recordable/Rewritable discs cannot be skipped. 	

	Symptoms	Causes/Remedies
Disc playback	<ul style="list-style-type: none"> • Not Support appears on the monitor. 	The format of the disc is supported.
	<ul style="list-style-type: none"> • Disc Error appears on the monitor. 	Insert the disc correctly again.
	<ul style="list-style-type: none"> • Eject Error or Loading Error appears on the monitor. 	The player may have malfunctioned. Eject the disc forcibly.
	<ul style="list-style-type: none"> • Sound and pictures are sometimes interrupted or distorted. 	<ul style="list-style-type: none"> • Stop playback while driving on rough roads. • Change the disc.
	<ul style="list-style-type: none"> • No playback picture appears on the monitor. 	Parking brake wire is not connected properly. (☞ Installation/Connection Manual.)
	<ul style="list-style-type: none"> • No sound is heard while playing back a DVD Audio. 	Some DVD Audios prohibit downmixed output. When you play back such a disc, the unit plays back the right front and left front signals only.
MP3/WMA/WAV playback	<ul style="list-style-type: none"> • Region Code Error appears on the monitor when you insert a DVD Video. 	Region code is not correct (☞ [61]).
	<ul style="list-style-type: none"> • Disc cannot be played back. 	<ul style="list-style-type: none"> • Change the disc. • Record the tracks using a compliant application in the appropriate discs (☞ [61]). • Add appropriate extension codes to the file names.
	<ul style="list-style-type: none"> • WMA track cannot be played back, and skipped. 	The track is copy-protected with DRM.
	<ul style="list-style-type: none"> • Noise is generated. 	The track played back is not a playable file. Skip to another file.
	<ul style="list-style-type: none"> • Tracks are not played back as you have intended. 	Playback order may differ from the one played back using other players.
	<ul style="list-style-type: none"> • A longer readout time is required. 	Readout time varies due to the complexity of the folder/file configuration. Do not use too many hierarchies and folders.
	<ul style="list-style-type: none"> • Elapsed playing time is not correct. 	This sometimes occurs during playback. This is caused by how the tracks are recorded.
	<ul style="list-style-type: none"> • Correct characters are not displayed (e.g. album name). 	This unit can only display alphabets (A – Z, a – z), numbers, and a limited number of symbols and some accented letters. Available characters ☞ [105]
	<ul style="list-style-type: none"> • No Files appears on the monitor. 	Insert a disc that contains tracks of proper formats.



	Symptoms	Causes/Remedies
Music server	<ul style="list-style-type: none">• Sound does not come out while copying music files.	This is not a malfunction.
	<ul style="list-style-type: none">• Sound does not come out in the map screen while recording a CD.	This is not a malfunction.
	<ul style="list-style-type: none">• Cannot change the source while recording/copying.	This is not a malfunction. If you want to enjoy another source, cancel recording/copying and change the source.
	<ul style="list-style-type: none">• Edited track name is not displayed.	Tag information instead of the track name is displayed. Set Tag Display to Off to display the track name. (☞ [90])
	<ul style="list-style-type: none">• No Music appears on the monitor.	No track is stored in the HDD.
	<ul style="list-style-type: none">• No Track or No Album appears on the monitor.	The selected item contains no tracks/albums. Select another.
	<ul style="list-style-type: none">• Cannot record tracks over. or Cannot copy tracks over. appears on the monitor.	The selected album is full. Select another album.
	<ul style="list-style-type: none">• Record only xx/XX tracks. or Copy only xx/XX tracks. appears on the monitor.	The selected album cannot contain all the tracks you wanted to record/copy. Press ENT to continue recording/copying, or press BACK to select another album.
	<ul style="list-style-type: none">• Move only xx/XX tracks? or Move only xx/XX albums? appears on the monitor.	The selected album/genre cannot contain all the items you wanted to move. Press ENT to continue moving the items, or press BACK to select another album/genre.
	<ul style="list-style-type: none">• HDD Full, Track Full, Album Full, or Genre Full appears on the monitor.	The capacity of the target storage you have selected is already full. Delete the unwanted items in the target storage to make an enough space.
	<ul style="list-style-type: none">• Write Error/Read Error appears and CD recording is canceled.	Recording is failed due to the external influences such as vibration, shaking of the car. Try to record once more while driving on a paved road. If the trouble still persist, consult your dealer.
	<ul style="list-style-type: none">• SCMS cannot Copy appears.	You have tried to copy non-original disc. Copy its original disc.
	<ul style="list-style-type: none">• Not Supported appears on the monitor.	The format of the track is not supported.
<ul style="list-style-type: none">• Not Playable appears on the monitor.	The selected track does not exist in the HDD.	

	Symptoms	Causes/Remedies
<i>CD changer</i>	<ul style="list-style-type: none"> • No Disc appears on the monitor. 	<ul style="list-style-type: none"> • Insert a disc into the magazine. • A disc is inserted upside down. Insert the disc correctly.
	<ul style="list-style-type: none"> • No Magazine appears on the monitor. 	Insert the magazine.
	<ul style="list-style-type: none"> • No Files appears on the monitor. 	Disc does not include playable files. Replace the disc with playable files.
	<ul style="list-style-type: none"> • Reset 08 appears on the monitor. 	Connect this unit and the CD changer correctly and press the reset button of the CD changer.
	<ul style="list-style-type: none"> • Reset 01 – Reset 07 appears on the monitor. 	Press the reset button of the CD changer.
	<ul style="list-style-type: none"> • The CD changer does not work at all. 	Reset the unit (☞ [4]).
<i>iPod/D. player playback</i>	<ul style="list-style-type: none"> • The iPod or D. player does not turn on or does not work. 	<ul style="list-style-type: none"> • Check the connecting cable and its connection. • Charge the battery. • For D. player: Update the firmware version.
	<ul style="list-style-type: none"> • The sound is distorted. 	Deactivate the equalizer either on this unit or the iPod/D. player.
	<ul style="list-style-type: none"> • Disconnect appears on the monitor. 	Check the connecting cable and its connection.
	<ul style="list-style-type: none"> • For iPod: Playback stops. 	The headphones are disconnected during playback. Restart playback.
	<ul style="list-style-type: none"> • No sound can be heard when connecting an iPod nano. 	Disconnect the headphones from the iPod nano.
	<ul style="list-style-type: none"> • No sound can be heard. • ERROR 01 appears on the monitor when connecting a D. player. 	Disconnect the adapter from the D. player. Then, connect it again.
	<ul style="list-style-type: none"> • No Files or No Track appears on the monitor. 	No tracks are stored. Import tracks to the iPod or D. player.
	<ul style="list-style-type: none"> • Reset 01 – Reset 07 appears on the monitor. 	Disconnect the adapter from both this unit and iPod/D. player. Then, connect it again.
	<ul style="list-style-type: none"> • Reset 08 appears on the monitor. 	Check the connection between the adapter and this unit.
	<ul style="list-style-type: none"> • The iPod's or D. player's controls do not work after disconnecting from this unit. 	Reset the iPod or D. player.



	Symptoms	Causes/Remedies
Bluetooth*	<ul style="list-style-type: none">Bluetooth device does not detect the unit.	This unit can be connected with one Bluetooth cellular phone and one Bluetooth audio device at a time. While connecting a device, this unit cannot be detected from another device. Disconnect currently connected device and search again.
	<ul style="list-style-type: none">The unit does not detect the Bluetooth device.	<ul style="list-style-type: none">Check the Bluetooth setting of the device.Search from the Bluetooth device. After the device detects the unit, select Open on the unit to connect the device. (☞ [84])
	<ul style="list-style-type: none">The unit does not make pairing with the Bluetooth device.	<ul style="list-style-type: none">Enter the same PIN code for both the unit and target device.Select the device name from Special Device, then try to connect again. (☞ [84])
	<ul style="list-style-type: none">Echo or noise occurs.	Adjust the microphone unit position.
	<ul style="list-style-type: none">Phone sound quality is poor.	<ul style="list-style-type: none">Place the Bluetooth audio device nearer to the adapter.Move the car to place where you can get a better signal reception.
	<ul style="list-style-type: none">The sound is interrupted or skipped during playback of a Bluetooth audio device.	<ul style="list-style-type: none">Place the Bluetooth audio device nearer to the adapter.Disconnect the device connected for “Bluetooth Phone.”Turn off, then turn on the unit.(When the sound is not yet restored,) connect the device again.
	<ul style="list-style-type: none">The connected audio device cannot be controlled.	Check whether the connected audio device supports AVRCP (Audio Video Remote Control Profile).

* For Bluetooth operations, refer also to the instructions supplied with the Bluetooth Adapter.

Glossary

Navigation System

GPS

Global Positioning System. By receiving the GPS signals from the satellites, the Navigation System determines the position of the car.

POI

Points of Interest. You can select your destinations by selecting from the categories—such as business centers, shopping centers.

TMC

Traffic Message Channel. Traffic messages transmitted by some VHF broadcasters via RDS signals. Using this data, the Navigation System informs you of road conditions.

Via Point

A location through which you reach your final destination. For this Navigation System, you can determine nine locations through which you can reach your final destination.

Playback sources

Dolby Digital

Compressed digital audio, developed by Dolby Laboratories, which enables multi-channel encode to create the realistic surround sound.

DTS

Compressed digital audio, developed by Digital Theater Systems, Inc., which enables multichannel like Dolby Digital. As the compression ratio is lower than for Dolby Digital, it provides wider dynamic range and better separation.

Linear PCM

Uncompressed digital audio, the same format used for CDs and most studio masters.

MPEG Audio

Another compressed digital audio which also enables multi-channel encode to create the realistic surround sound.

On-screen guide

While operating the built-in DVD/CD player, operation modes are displayed on the monitor. (☞ [102])

UDF-Bridge Format

A hybrid file system used to provide compatibility with ISO 9660 for accessing any type of files on the disc. (UDF stands for Universal Disk Format.)

WMA

Windows Media Audio. A compression process developed by Microsoft® for compressing audio data (i.e. music).

Specifications



Navigation System	System & Service	L1, C/A code Global Positioning System Standard Positioning Service		
	Reception System	15-channel multi-channel reception system		
	Reception Frequency	1 575.42 MHz		
	Sensitivity	-130 dBm		
	Update Rate	1/second, continuous		
	GPS Antenna	Polarization	Right Handed Circular Polarization	
		Dimensions (approx.) (W × H × D)	30.4 mm × 11.7 mm × 35.5 mm (1-1/4 inches × 1/2 inch × 1-7/16 inches)	
Cable (approx.)		5.0 m (16.4 feet)		
Attachment mat size (approx.)		70 mm × 70 mm (2-13/16 inches × 2-13/16 inches)		

Amplifier	Power Output	20 W RMS × 4 Channels at 4 Ω and ≤ 1% THD+N		
	Signal to Noise Ratio	80 dBA (reference: 1 W into 4 Ω)		
	Load Impedance	4 Ω (4 Ω to 8 Ω allowance)		
	Equalizer Control Range	Frequencies	60 Hz, 150 Hz, 400 Hz, 1 kHz, 2.4 kHz, 6 kHz, 12 kHz	
		Level	±10 dB	
	Audio output level	Line-Out Level/ Impedance	2.5 V/20 kΩ load (full scale)	
		Output Impedance	1 kΩ	
	Digital (DIGITAL OUT: Optical)	Signal wave length	660 nm	
		Output level	-21 dBm to -15 dBm	
	Color system	NTSC		
	Video output (composite)	1 V _{p-p} /75 Ω		
	Video input (composite)	1 V _{p-p} /75 Ω		
	Other Terminals	Input	VIDEO IN, steering wheel remote input	
Output		VIDEO OUT, LINE OUT (FRONT), LINE OUT (REAR), SUBWOOFER OUT		
Others		CD changer		

Tuner	Frequency Range	FM (with channel interval set to 100 kHz or 200 kHz):	87.5 MHz to 107.9 MHz
		FM (with channel interval set to 50 kHz):	87.5 MHz to 108.0 MHz
		AM (with channel interval set to 10 kHz):	530 kHz to 1 710 kHz
		AM (with channel interval set to 9 kHz):	531 kHz to 1 602 kHz
	FM Tuner	Usable Sensitivity	11.3 dBf (1.0 μ V/75 Ω)
		50 dB Quieting Sensitivity	16.3 dBf (1.8 μ V/75 Ω)
		Alternate Channel Selectivity (400 kHz)	65 dB
		Frequency Response	40 Hz to 15 000 Hz
		Stereo Separation	40 dB
		Capture Ratio	1.5 dB
	AM Tuner	Sensitivity	20 μ V
		Selectivity	65 dB

DVD/CD Player	Signal Detection System		Non-contact optical pickup (semiconductor laser)	
	Number of Channels		2 channels (stereo)	
	Frequency Response	DVD, fs=48 kHz/96 kHz	16 Hz to 20 000 Hz	
		DVD, fs=192 kHz	16 Hz to 20 000 Hz	
		VCD/CD	16 Hz to 20 000 Hz	
	Dynamic Range		96 dB	
	Signal-to-Noise Ratio		98 dB	
	Wow and Flutter		Less than measurable limit	
	DivX	Video	Max. Resolution	720 x 480 pixels (30 fps) 720 x 576 pixels (25 fps)
			Audio	Bit Rate
		Sampling Frequency	MPEG-1: 32 kHz, 44.1 kHz, 48 kHz MPEG-2: 16 kHz, 22.05 kHz, 24 kHz	
	MPEG Video	Video	Max. Resolution	720 x 480 pixels (30 fps) 720 x 576 pixels (25 fps)
			Audio	Bit Rate
		Sampling Frequency	32 kHz, 44.1 kHz, 48 kHz	
	MP3 (MPEG Audio Layer 3)		Max. Bit Rate: 320 Kbps	
	WMA (Windows Media® Audio)		Max. Bit Rate: 320 Kbps	



HDD	HDD	40 GB (Map data: 16 GB / Storage: 24 GB)
	MP3 (MPEG Audio Layer 3)	Max. Bit Rate: 320 kbps
	WMA (Windows Media® Audio)	Max. Bit Rate: 320 kbps

Monitor	Screen size	3.5 inch wide liquid crystal display
	Number of Pixel	224 640 pixels: 320 (horizontal) × 3 × 234 (vertical)
	Drive Method	TFT (Thin Film Transistor) active matrix format
	Color System	NTSC
	Aspect Ratio	16:9 (wide)

General	Power Requirement	Operating Voltage	DC 14.4 V (11 V to 16 V allowance)
	Grounding System		Negative ground
	Allowable Storage Temperature		-10°C to +60°C (14°F to 140°F)
	Allowable Operating Temperature		0°C to +40°C (32°F to 104°F)
	Allowable Operating Altitude		-300 m to +3 000 m (-980 feet to +9 800 feet)
	Dimensions (approx.) (W × H × D)	Installation Size	182 mm × 52 mm × 158 mm (7-3/16 inches × 2-1/16 inches × 6-1/4 inches)
		Panel Size	188 mm × 58 mm × 12 mm (7-7/16 inches × 2-5/16 inches × 1/2 inch)
	Mass (approx.)		2.2 kg (4.9 lbs) (excluding accessories)

Design and specifications are subject to change without notice.

If a kit is necessary for your car, consult your telephone directory for the nearest car audio speciality shop.

- DivX, DivX Ultra Certified, and associated logos are trademarks of DivX, inc. and are used under license.
- Official DivX® Ultra Certified product
- Plays all versions of DivX® video (including DivX® 6) with enhanced playback of DivX® media files and the DivX® Media Format
- “DTS” is a registered trademark of DTS, Inc. and “DTS 2.0 + Digital Out” is a trademark of DTS, Inc.
- Microsoft and Windows Media are either registered trademarks or trademarks of Microsoft Corporation in the United States and/or other countries.
- “DVD Logo” is a trademark of DVD Format/Logo Licensing Corporation registered in the US, Japan and other countries.
- Manufactured under license from Dolby Laboratories. Dolby and the double-D symbol are trademarks of Dolby Laboratories.



Having TROUBLE with operation?

Please reset your unit

Refer to page of How to reset your unit

Still having trouble??

USA ONLY

Call 1-800-252-5722

<http://www.jvc.com>

We can help you!

JVC

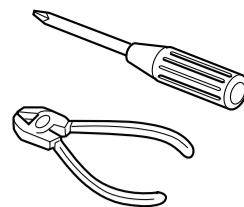

ENGLISH

This unit is designed to operate on **12 V DC, NEGATIVE ground electrical systems**. If your vehicle does not have this system, a voltage inverter is required, which can be purchased at JVC car audio dealers.

WARNINGS

- DO NOT install any unit in locations where:
 - it may obstruct the steering wheel and gearshift lever operations.
 - it may obstruct the operation of safety devices such as air bags.
 - it may obstruct visibility.
- DO NOT operate the unit while driving. If you need to operate the unit while driving, be sure to look ahead carefully.
- The driver must not watch the monitor while driving.
- This unit has a built-in HDD, which is a device to read minute magnetic changes. The inside of the device is precision components, requiring you to notice the following when installing the unit:
 - Dry and neither too hot nor too cold—between 5°C (41°F) and 35°C (95°F). If the temperature is too low, the HDD will not work. Wait until the temperature in the car becomes normal before operating the unit.
 - At an altitude between -300 m (-980 ft) below sea level and +3000 m (9800 ft) above sea level.
 - With adequate ventilation to prevent internal heat buildup in the unit.

ESPAÑOL

Esta unidad está diseñada para funcionar con **12 V de CC, con sistemas eléctricos de masa NEGATIVA**. Si su vehículo no posee este sistema, será necesario un inversor de tensión, que puede ser adquirido en los concesionarios de JVC de equipos de audio para automóviles.

ADVERTENCIAS

- NO instale la unidad en los siguientes sitios:
 - puede obstaculizar las maniobras del volante de dirección y de la palanca de cambios.
 - puede obstaculizar la operación de los dispositivos de seguridad, como por ejemplo, bolsas de aire.
 - Donde pueda obstruir la visibilidad.
- NO opere la unidad mientras maneja. Si es necesario operar la unidad mientras maneja, asegúrese de no apartar la vista de la carretera.
- El conductor no debe mirar el monitor mientras conduce.
- Esta unidad dispone de un HDD incorporado, que es un dispositivo que lee los cambios magnéticos diminutos. En el interior del dispositivo hay componentes de precisión y por lo tanto, se deberá tener en cuenta lo siguiente al instalar la unidad.
 - Instale la unidad en un lugar que cumpla con las siguientes condiciones:
 - Nivelado y seco, ni demasiado frío ni demasiado caluroso—entre 5°C (41°F) y 35°C (95°F). El HDD no funcionará si la temperatura es muy baja. Antes de operar la unidad, espere hasta que la temperatura del habitáculo se normalice.
 - A una altitud entre -300 m (-980 pie) por debajo del nivel del mar y +3000 m (9800 pie) por encima del nivel del mar.
 - Con una ventilación adecuada para evitar la generación de calor en el interior de la unidad.

FRANÇAIS

Cet appareil est conçu pour fonctionner sur des sources de **courant continu de 12 V à masse NEGATIVE**. Si votre véhicule n'offre pas ce type d'alimentation, il vous faut un convertisseur de tension, que vous pouvez acheter chez un revendeur d'autoradios JVC.

AVERTISSEMENTS

- N'INSTALLEZ aucun appareil dans les endroits suivants où:
 - il peut gêner l'utilisation du volant ou du levier de vitesse.
 - il peut gêner le fonctionnement de dispositifs de sécurité tels que les coussins de sécurité.
 - il peut gêner la visibilité.
- NE manipulez pas l'appareil quand vous conduisez. Si vous devez commander l'appareil pendant que vous conduisez, assurez-vous de bien regarder devant vous.
- Le conducteur ne doit pas regarder le moniteur lorsqu'il conduit.
- Cet appareil contient un disque dur intégré, qui est dispositif permettant de lire les charges magnétiques minuscules. L'intérieur de l'appareil est composé de dispositifs de précision, vous demandant de prendre les précautions suivantes lors de l'installation de l'appareil:
 - Installez l'appareil dans un endroit où les conditions suivantes sont satisfaites:
 - Sec et ni trop chaud ni trop froid—entre 5°C (41°F) et 35°C (95°F). Si la température est trop basse, le disque dur ne fonctionne pas. Attendez que la température dans la voiture redevienne normale avant d'utiliser l'appareil.
 - À une altitude située entre -300 m (-980 pied) au-dessous du niveau de la mer et +3000 m (9800 pied) au-dessus du niveau de la mer.
 - Avec une ventilation suffisante pour éviter tout échauffement interne de l'appareil.

Parts list for installation and connection

The following parts are provided for this unit. If anything is missing, contact your dealer immediately.

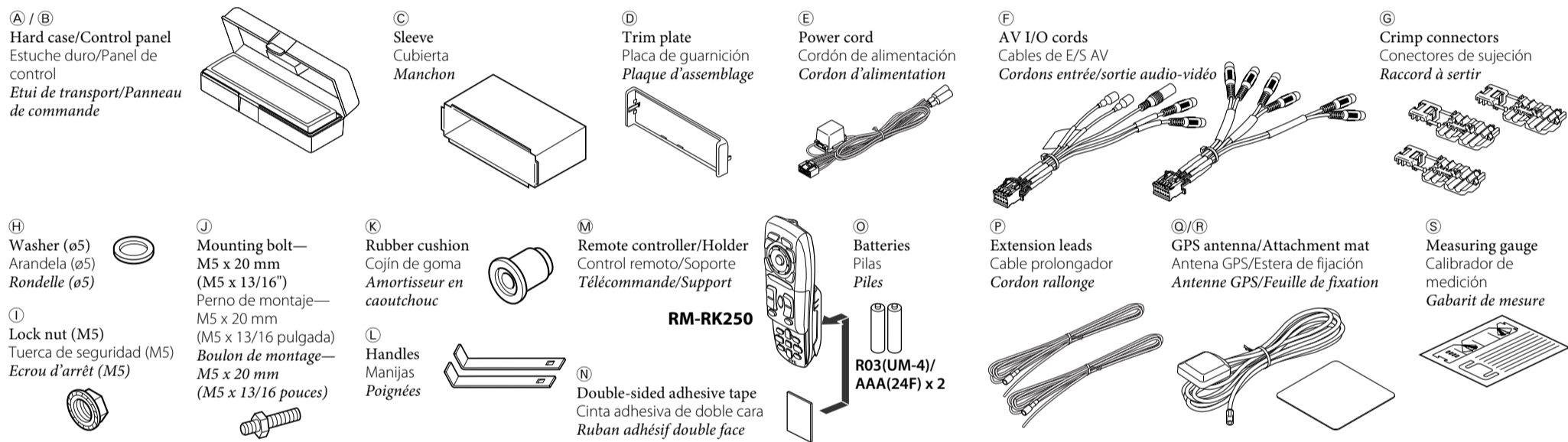

Lista de piezas para instalación y conexión

Con esta unidad se suministran las siguientes piezas. Después de inspeccionarlas, colóquelas correctamente.

Liste des pièces pour l'installation et raccordement

Les pièces suivantes sont fournies avec cet appareil. Après vérification, veuillez les placer correctement.

Required space for installation / Espacio requerido para la instalación / Espace nécessaire pour l'installation

- You cannot install the unit on the car which has any obstacles in the diagonally shaded areas.
- No es posible instalar la unidad en el coche si hay obstáculos en las zonas sombreadas laterales.
- Vous ne pouvez pas installer l'unité dans une voiture comportant des obstacles dans les zones ombrées sur l'illustration.

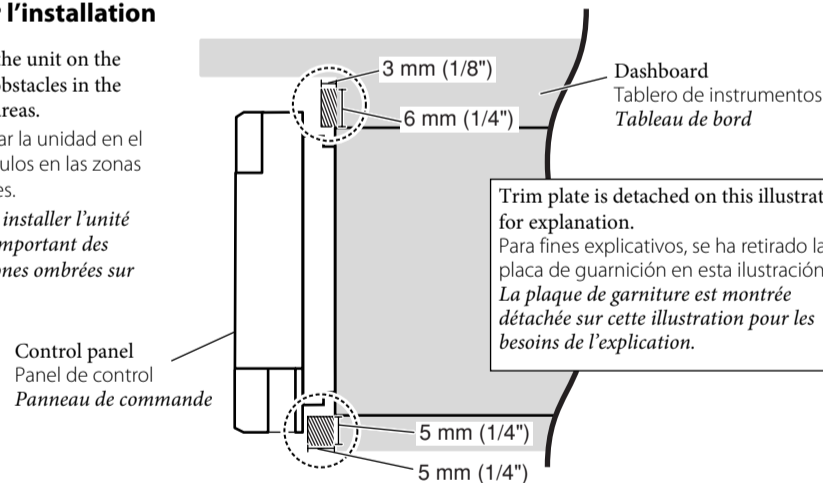

Installing the remote controller / Instalación del control remoto / Installation de la télécommande

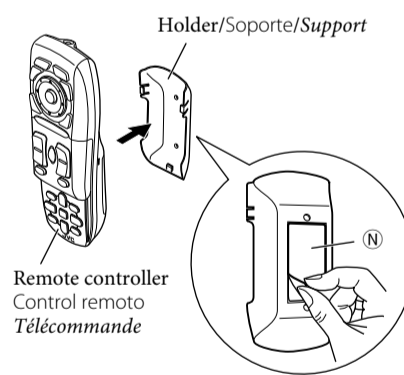

Caution when installing / Precaución en la instalación / Précautions lors de l'installation

- Fit the unit into the mounting sleeve by using four corners of the trim plate.
- DO NOT press the panel (shaded in the illustration).
- Introduzca el receptor en la manga de montaje utilizando las cuatro esquinas de la placa decorativa.
- NO presione el panel (sombreado en la ilustración).
- Fixez l'autoradio sur le manchon de montage en utilisant les quatre coins de la plaque de garniture.
- NE PUSSEZ PAS sur le panneau (en gris sur l'illustration).

TROUBLESHOOTING

- **The fuse blows.**
 - * Are the red and black leads connected correctly?
- **Power cannot be turned on.**
 - * Is the yellow lead connected?
- **No sound from the speakers.**
 - * Is the speaker output lead short-circuited?
- **Sound is distorted.**
 - * Is the speaker output lead grounded?
 - * Are the "-" terminals of L and R speakers grounded in common?
- **Noise interfere with sounds.**
 - * Is the rear ground terminal connected to the car's chassis using shorter and thicker cords?
- **No playback picture appears while an AV source is selected.**
 - * Is the parking brake lead properly connected?
- **Unit becomes hot.**
 - * Is the speaker output lead grounded?
 - * Are the "-" terminals of L and R speakers grounded in common?
- **This unit does not work at all.**
 - * Have you reset your unit?

LOCALIZACION DE AVERIAS

- **El fusible se quema.**
 - * ¿Están los conductores rojo y negro correctamente conectados?
- **No es posible conectar la alimentación.**
 - * ¿Está el cable amarillo conectado?
- **No sale sonido de los altavoces.**
 - * ¿Está el cable de salida del altavoz cortocircuitado?
- **El sonido presenta distorsión.**
 - * ¿Está el cable de salida del altavoz conectado a masa?
 - * ¿Están los terminales "-" de los altavoces L y R conectados a una masa común?
- **Perturbación de ruido.**
 - * ¿El terminal de tierra trasero está conectado al chasis del automóvil utilizando los cordones más corto y más grueso?
- **No aparece la reproducción de imágenes mientras se selecciona la fuente de AV.**
 - * ¿Se ha conectado correctamente el cable del freno de estacionamiento?
- **La unidad se calienta.**
 - * ¿Está el cable de salida del altavoz conectado a masa?
 - * ¿Están los terminales "-" de los altavoces L y R conectados a una masa común?
- **Este receptor no funciona en absoluto.**
 - * ¿Reinicializó el receptor?

EN CAS DE DIFFICULTES

- **Le fusible saute.**
 - * Les fils rouge et noir sont-ils raccordés correctement?
- **L'appareil ne peut pas être mise sous tension.**
 - * Le fil jaune est-elle raccordée?
- **Pas de son des enceintes.**
 - * Le fil de sortie d'enceinte est-il court-circuité?
- **Le son est déformé.**
 - * Le fil de sortie d'enceinte est-il à la masse?
 - * Les bornes "-" des enceintes gauche et droit sont-elles mises ensemble à la masse?
- **Interférence avec les sons.**
 - * La prise arrière de mise à la terre est-elle connectée au châssis de la voiture avec un cordon court et épais?
- **Aucune image de lecture n'apparaît lors de la sélection d'une source audio-vidéo.**
 - * Le fil de sortie du frein de stationnement est-il connecté correctement?
- **L'appareil devient chaud.**
 - * Le fil de sortie d'enceinte est-il à la masse?
 - * Les bornes "-" des enceintes gauche et droit sont-elles mises ensemble à la masse?
- **Cet appareil ne fonctionne pas du tout.**
 - * Avez-vous réinitialisé votre appareil?

INSTALLATION (IN-DASH MOUNTING)

The following illustration shows a typical installation. If you have any questions or require information regarding installation kits, consult your JVC car audio dealer or a company supplying kits.

- If you are not sure how to install this unit correctly, have it installed by a qualified technician.
- Make sure not to block the fan on the rear panel to maintain proper ventilation when installed.

INSTALACION (MONTAJE EN EL TABLERO DE INSTRUMENTOS)

La siguiente ilustración muestra una instalación típica. Si tiene alguna pregunta o necesita información acerca de las herramientas para instalación, consulte con su concesionario de JVC de equipos de audio para automóviles o a una compañía que suministra tales herramientas.

- Si usted no está seguro de cómo instalar correctamente la unidad, hágala instalar por un técnico cualificado.
- Asegúrese de no bloquear las rendijas de ventilación del panel trasero, para poder mantener una buena ventilación una vez instalado.

INSTALLATION (MONTAGE DANS LE TABLEAU DE BORD)

L'illustration suivante est un exemple d'installation typique. Si vous avez des questions ou avez besoin d'information sur des kits d'installation, consultez votre revendeur d'autoradios JVC ou une compagnie d'approvisionnement.

- Si l'on n'est pas sûr de pouvoir installer correctement cet appareil, le faire installer par un technicien qualifié.
- Lors de l'installation assurez-vous de ne pas bloquer le ventilateur à l'arrière afin de permettre une ventilation correcte.

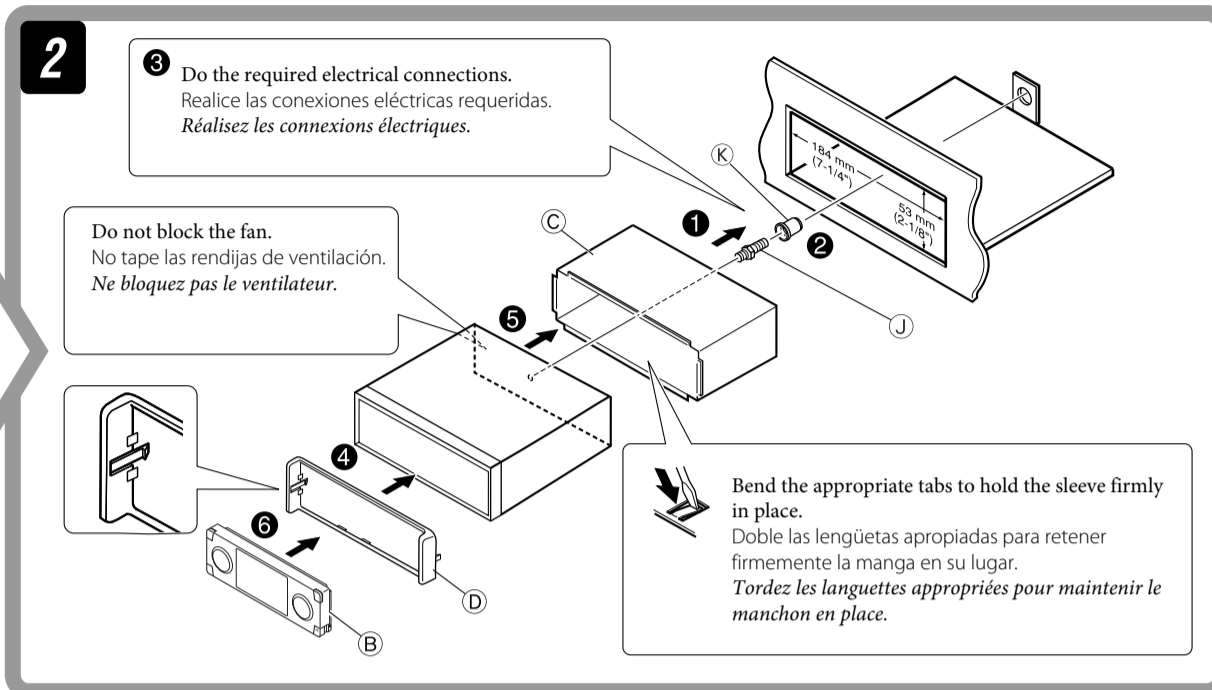
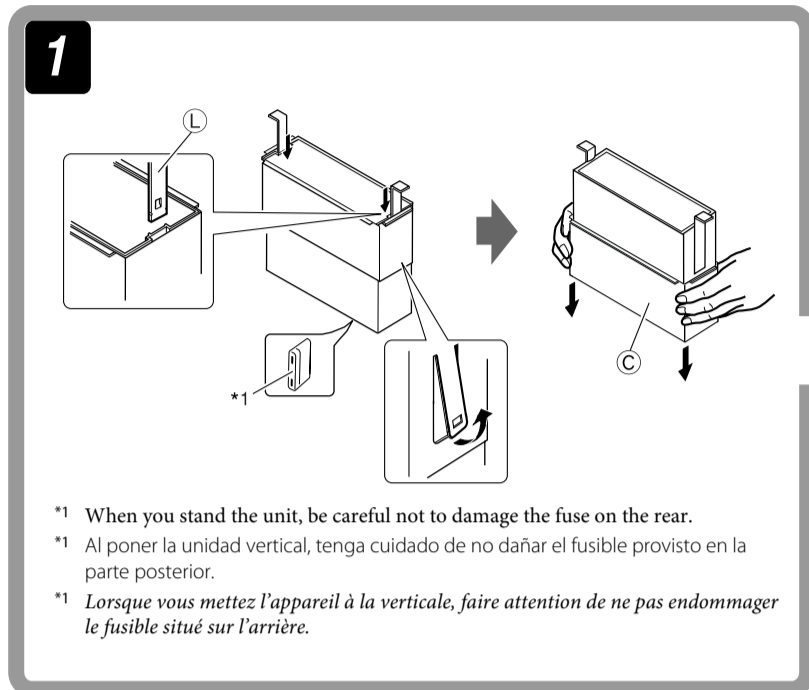

When using the optional stay / Cuando emplea un soporte opcional / Lors de l'utilisation du hauban en option

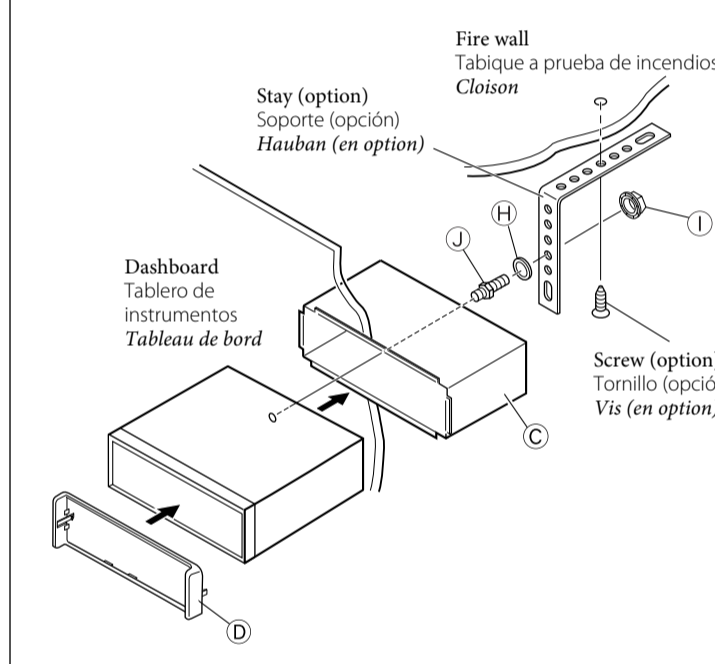

When installing the unit without using the sleeve / Instalación de la unidad sin utilizar la cubierta / Lors de l'installation de l'appareil sans utiliser de manchon

In a car having the "Required space for installation" (see page 1), first remove the car radio and install the unit in its place. En un automóvil que dispone del "Espacio requerido para la instalación" (véase página 1), primero desmonte el autorradio e instale la unidad en su lugar. Dans une voiture possédant l'"Espace nécessaire pour l'installation" (voir page 1), retirez d'abord l'autoradio d'origine et installez cet appareil à sa place.

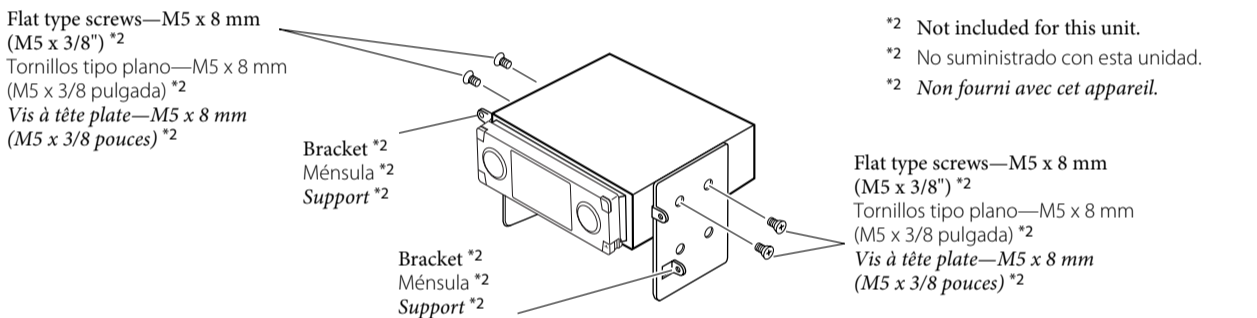

- Note** : When installing the unit on the mounting bracket, make sure to use the 8 mm (3/8") -long screws. If longer screws are used, they could damage the unit.
- Nota** : Cuando instala la unidad en la ménsula de montaje, asegúrese de utilizar los tornillos de 8 mm (3/8 pulgada) de longitud. Si se utilizan tornillos más largos, éstos pueden dañar la unidad.
- Remarque** : Lors de l'installation de l'appareil sur le support de montage, s'assurer d'utiliser des vis d'une longueur de 8 mm (3/8 pouces). Si des vis plus longues sont utilisées, elles peuvent endommager l'appareil.

- Install the unit at an angle of less than 30° vertically and of less than 5° horizontally.
- After installation, confirm the vertical angle of the unit using the supplied measuring gauge.
- Instale la unidad a un ángulo de menos de 30° en sentido vertical, y de menos de 5° en sentido horizontal.
- Después de la instalación, confirme el ángulo vertical de la unidad con el calibrador de medición suministrado.
- Installez l'appareil avec un angle vertical de moins de 30° et un angle horizontal de moins de 5°.
- Après l'installation, vérifiez l'angle vertical de l'appareil en utilisant le gabarit de mesure fourni.

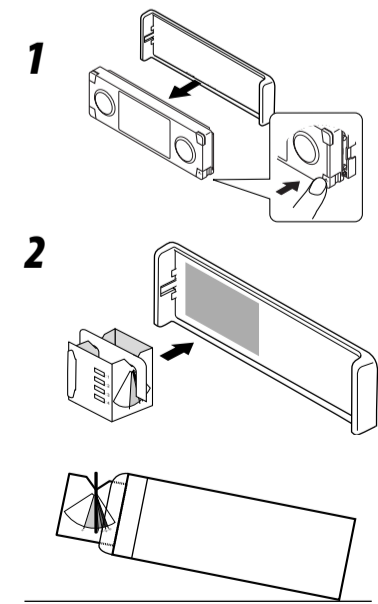
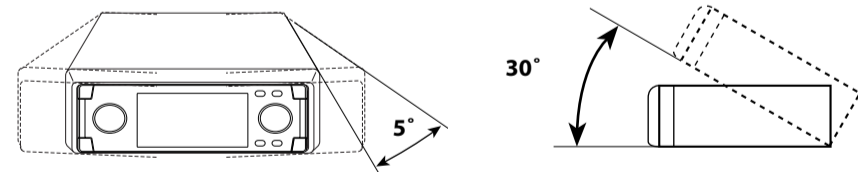

Measuring the installation angle

- BEFORE starting, make sure...
- You have parked the car where it cannot be inclined. (It should be parked horizontally.)
- 1 Detach the control panel.
 - 2 Measure the angle.
 - Attach the measuring gauge closely and flatly to the main unit (to the portion shaded in the illustration on the left).
 - 3 Note your measured angle.
 - ①: -5.0 to 1.0°
 - ②: 1.0 to 6.0°
 - ③: 6.0 to 14.0°
 - ④: 14.0 to 32.0°*

* It is not recommended to install the main unit at an angle of more than 30°; otherwise, the malfunction may result.

When you use the Navigation System for the first time after installation... Follow the procedure described on pages 8 and 9 of the INSTRUCTIONS (separate volume).

Assembling the measuring gauge / Montaje del calibrador de medición / Assemblage du gabarit de mesure

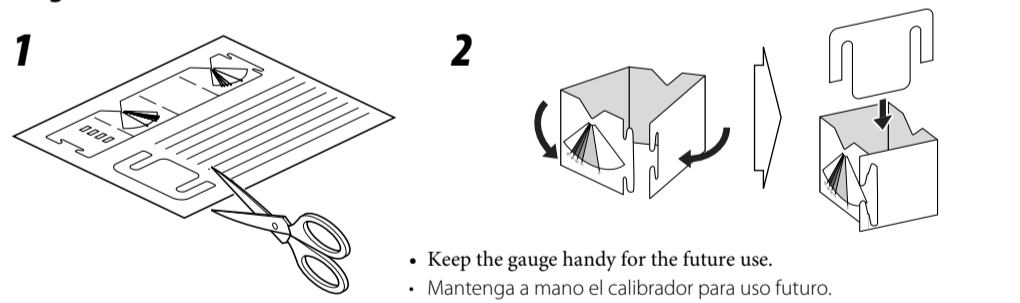

- Keep the gauge handy for the future use.
- Mantenga a mano el calibrador para uso futuro.
- Conservez le gabarit à portée de main pour une utilisation future.

Medición del ángulo de instalación

- ANTES de empezar, compruebe que...
- Ha estacionado el automóvil en un sitio no inclinado. (Estacionar sobre una superficie plana.)
- 1 Desmonte el panel de control.
 - 2 Mida el ángulo.
 - Acople el patrón de medida de forma que quede plano y cerca de la unidad principal, en la parte sombreada que se muestra en la parte izquierda de la ilustración.
 - 3 Anote el ángulo medido.
 - ①: -5,0 a 1,0°
 - ②: 1,0 a 6,0°
 - ③: 6,0 a 14,0°
 - ④: 14,0 a 32,0°*

* Se recomienda no instalar la unidad principal a un ángulo de más de 30° pues de lo contrario, podrían producirse fallos de funcionamiento.

Cuando utilice el sistema de navegación por primera vez después de la instalación... Realice el procedimiento descrito en las páginas 8 y 9 del MANUAL DE INSTRUCCIONES (volumen separado).

Mesure de l'angle d'installation

- AVANT de commencer, assurez-vous que...
- Vous avez garé votre voiture dans un endroit où elle n'est pas inclinée. (Elle doit être garée horizontalement.)
- 1 Détachez le panneau de commande.
 - 2 Mesurez l'angle.
 - Attachez le gabarit de mesure étroitement et à plat sur l'unité principale (partie ombrée sur l'illustration de gauche).
 - 3 Notez l'angle mesuré.
 - ①: -5,0 à 1,0°
 - ②: 1,0 à 6,0°
 - ③: 6,0 à 14,0°
 - ④: 14,0 à 32,0°*

* Il n'est pas recommandé d'installer l'appareil avec un angle de plus de 30°; sinon, cela peut entraîner un mauvais fonctionnement.

Quand vous utilisez l'autoradio pour la première fois après l'installation... Suivez la procédure décrite aux pages 8 et 9 du MANUEL D'INSTRUCTIONS (volume séparé).

Removing the unit

Before removing the unit, release the rear section.

Extracción de la unidad

Antes de extraer la unidad, libere la sección trasera.

Retrait de l'appareil

Avant de retirer l'appareil, libérer la section arrière.

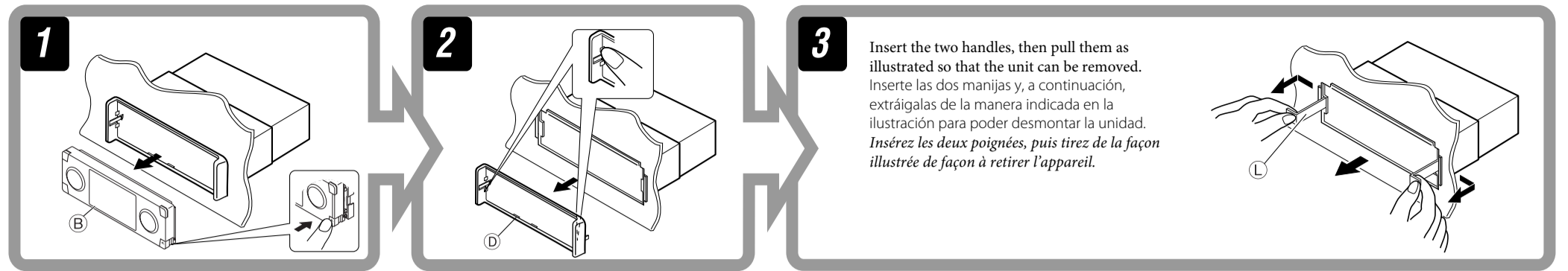

Installing the GPS antenna

- People who use pacemakers should avoid a physical contact with the magnetic antenna and should not handle it themselves. This causes malfunctions of the pacemakers.
- Keep the magnetic antenna away from the storage media such as disks, credit cards; otherwise, its data will be collapsed.
- The antenna should be attached so firmly that it cannot be detached in the event of a collision or sudden braking.

Instalación de la antena GPS

- Las personas portadoras de marcapasos deben evitar el contacto físico con la antena magnética, y deben abstenerse de intentar su manejo. Esto puede producir un fallo de funcionamiento en el marcapasos.
- Mantenga la antena magnética alejada de los medios de almacenaje como por ejemplo disquetes, tarjetas de crédito, y otros, pues se dañarán los datos.
- Sujete la antena firmemente, para evitar que se salga en el caso eventual de un choque o de un frenado brusco.

Installation de l'antenne GPS

- Les personnes utilisant un stimulateur cardiaque doivent éviter tout contact physique avec l'antenne magnétique et ne doivent pas la manipuler elles-mêmes. Cela pourrait entraîner un dysfonctionnement du stimulateur cardiaque.
- Tenez l'antenne magnétique à distance des supports de mémoire tels que les disques, les cartes de crédit; sinon, les données pourraient être corrompues.
- L'antenne doit être fixée suffisamment solidement pour qu'elle ne puisse pas se détacher en cas de choc ou de coup de frein brutal.

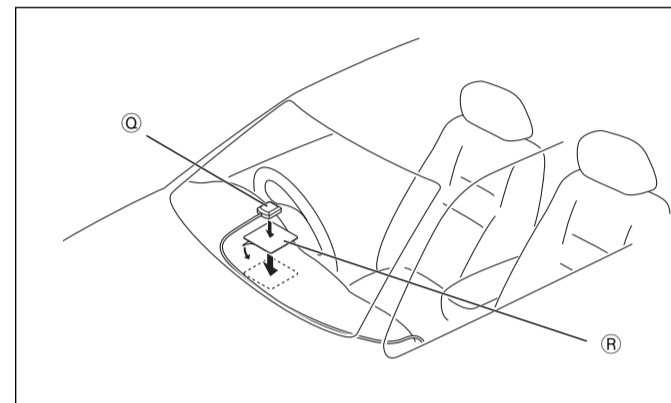

A Inside the car

Beneath a non-metallised* window, fix the attachment mat (R) on the dashboard, then place the antenna (A) on the mat.

- Make sure that the antenna is not covered by any components and parts of the car and it can receive the signals from all directions.
- * The windows with screen antenna, windshield heating or thermally insulated screens will interfere with GPS reception, and will degrade the reliability of the Navigation System.

A Dentro del automóvil

Detrás de un cristal no metalizado*, fije la estera de fijación (R) sobre el cubretablero y ponga la antena (A) sobre la estera.

- Asegúrese de no tapan la antena con ningún componente ni pieza del automóvil, y de que la recepción de la señal es posible desde todas las direcciones.
- * Las ventanillas que cuentan con antenas con pantalla, calefacción en el cristal del parabrisas o pantallas térmicamente aisladas interfieren con la recepción GPS, y disminuirán la confiabilidad del sistema de navegación.

A À l'intérieur de la voiture

Derrière une fenêtre non métallisée*, fixez la feuille de fixation (R) sur le tableau de bord, puis placez l'antenne (A) sur la feuille.

- Assurez-vous que l'antenne n'est recouverte par aucun composant ou aucune partie de la voiture et peut recevoir les signaux de toutes les directions.
- * Les vitres avec une antenne incrustée, les chauffages de pare-brise ou les écrans d'isolation thermique interfèrent avec la réception GPS et réduisent la fiabilité du système de navigation.

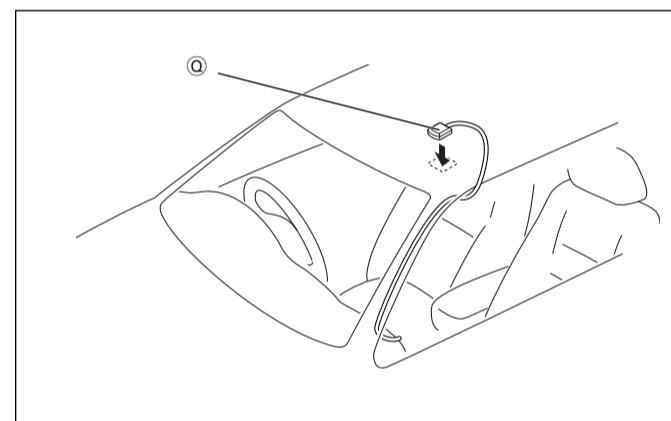

B Outside the car

Fix the antenna (B) to a pre-washed, flat, metallic surface.

- Wire the antenna cord so as not to allow the rain to leak in.
- The antenna magnetically attached will be used even at a speed of 180 km/h (110 mi/h) (maximum). The antenna must be specially secured for higher speeds.
- Detach the antenna before you wash the car with the car-wash facilities.

B Fuera del automóvil

Fije la antena (B) sobre una superficie metálica plana, previamente lavada.

- Procure tender el cable de antena para no permitir la entrada de lluvia.
- La antena fijada magnéticamente puede utilizarse incluso a velocidades del orden de 180 km/h (110 mi/h) (máximo). Para velocidades superiores, la antena deberá estar especialmente asegurada.
- Desmonte la antena antes de lavar el automóvil en un lavacoches automático.

B À l'extérieur de la voiture

Fixez l'antenne (B) sur une surface métallique plate.

- Câblez le cordon d'antenne de façon à empêcher la pluie de pénétrer à l'intérieur.
- Une fois fixée, l'antenne magnétique ne se détachera pas même à une vitesse de 180 km/h (110 mi/h) (maximum). L'antenne doit être fixée spécialement pour les vitesses plus élevées.
- Détachez l'antenne avant de laver votre voiture dans un poste de lavage.

ELECTRICAL CONNECTIONS

To prevent short circuits, we recommend that you disconnect the battery's negative terminal and make all electrical connections before installing the unit.

- **Be sure to ground this unit to the car's chassis again after installation.**

Notes:

- Replace the fuse with one of the specified rating. If the fuse blows frequently, consult your JVC car audio dealer.
- It is recommended to connect to the speakers with maximum power of more than 50 W (both at the rear and at the front, with an impedance of **4 Ω to 8 Ω**). If the maximum power is less than 50 W, change "Amplifier Gain" setting to prevent the speakers from being damaged (see page 95 of the INSTRUCTIONS).
- To prevent short-circuit, cover the terminals of the UNUSED leads with insulating tape.
- The heat sink becomes very hot after use. Be careful not to touch it when removing this unit.

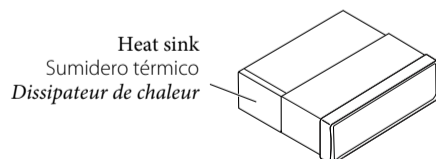

CONEXIONES ELECTRICAS

Para evitar cortocircuitos, recomendamos que desconecte el terminal negativo de la batería y que efectúe todas las conexiones eléctricas antes de instalar la unidad.

- **Asegúrese de volver a conectar a masa esta unidad al chasis del automóvil después de la instalación.**

Notas:

- Reemplace el fusible por uno con la corriente especificada. Si el fusible se quemase frecuentemente consulte con su concesionario de JVC de equipos de audio para automóviles.
- Se recomienda conectar los altavoces con una potencia máxima de más de 50 W (tanto atrás como adelante, con una impedancia de **4 Ω a 8 Ω**). Si la potencia máxima es de menos de 50 W, cambie "Gcia.amplific." para evitar daños en los altavoces (consulte la página 95 del MANUAL DE INSTRUCCIONES).
- Para evitar cortocircuitos, cubra los cables NO UTILIZADOS con cinta aislante.
- El sumidero térmico estará muy caliente después del uso. Asegúrese de no tocarlo al desmontar esta unidad.

RACCORDEMENTS ELECTRIQUES

Pour éviter tout court-circuit, nous vous recommandons de débrancher la borne négative de la batterie et d'effectuer tous les raccordements électriques avant d'installer l'appareil.

- **Assurez-vous de raccorder de nouveau la mise à la masse de cet appareil au châssis de la voiture après l'installation.**

Remarques:

- Remplacer le fusible par un de la valeur précisée. Si le fusible saute souvent, consulter votre revendeur d'autoradios JVC.
- Il est recommandé de connecter des enceintes avec une puissance de plus de 50 W (les enceintes arrière et les enceintes avant, avec une impédance comprise entre **4 Ω et 8 Ω**). Si la puissance maximum est inférieure à 50 W, changez "Gain amplif." pour éviter d'endommager vos enceintes (voir page 95 du MANUEL D'INSTRUCTIONS).
- Pour éviter les court-circuits, couvrir les bornes des fils qui ne sont PAS UTILISÉS avec de la bande isolante.
- Le dissipateur de chaleur devient très chaud après usage. Faire attention de ne pas le toucher en retirant cet appareil.

PRECAUTIONS on power supply and speaker connections:

- **DO NOT connect the speaker leads of the power cord to the car battery; otherwise, the unit will be seriously damaged.**
- BEFORE connecting the speaker leads of the power cord to the speakers, check the speaker wiring in your car.

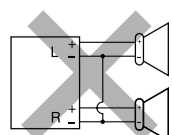

PRECAUCIONES sobre las conexiones de la fuente de alimentación y de los altavoces:

- **NO conecte los conductores de altavoz del cable de alimentación a la batería de automóvil, pues podrían producirse graves daños en la unidad.**
- ANTES de conectar a los altavoces los conductores de altavoz del cable de alimentación, verifique el conexionado de altavoz de su automóvil.

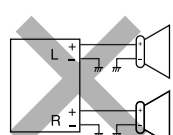

PRECAUTIONS sur l'alimentation et la connexion des enceintes:

- **NE CONNECTEZ PAS les fils d'enceintes du cordon d'alimentation à la batterie; sinon, l'appareil serait sérieusement endommagé.**
- AVANT de connecter les fils d'enceintes du cordon d'alimentation aux enceintes, vérifiez le câblage des enceintes de votre voiture.

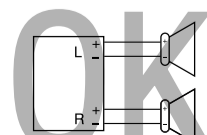

A Typical Connections / Conexiones típicas / Raccordements typiques

Before connecting: Check the wiring in the vehicle carefully. Incorrect connection may cause serious damage to this unit.
The leads of the power cord and those of the connector from the car body may be different in color.

- 1 Connect the colored leads of the power cord in the order specified in the illustration below.
- 2 Connect the antenna cord and the GPS antenna.
- 3 Finally connect the wiring harness to the unit.

Antes de la conexión: Verifique atentamente el conexionado del vehículo. Una conexión incorrecta podría producir daños graves en la unidad.
Los cordones del cable de alimentación y los del conector procedentes de la carrocería del automóvil podrían ser de diferentes en color.

- 1 Conecte los conductores de color del cable de alimentación en el orden especificado en la ilustración de abajo.
- 2 Conecte el cable de antena y la antena GPS.
- 3 Por último, conecte el cable de alimentación a la unidad.

Avant de commencer la connexion: Vérifiez attentivement le câblage du véhicule. Une connexion incorrecte peut endommager sérieusement l'appareil.
Le fil du cordon d'alimentation et ceux des connecteurs du châssis de la voiture peuvent être différents en couleur.

- 1 Connectez les fils colorés du cordon d'alimentation dans l'ordre spécifié sur l'illustration ci-dessous.
- 2 Connectez le cordon d'antenne et l'antenne GPS.
- 3 Finalement, connectez le faisceau de fils à l'appareil.

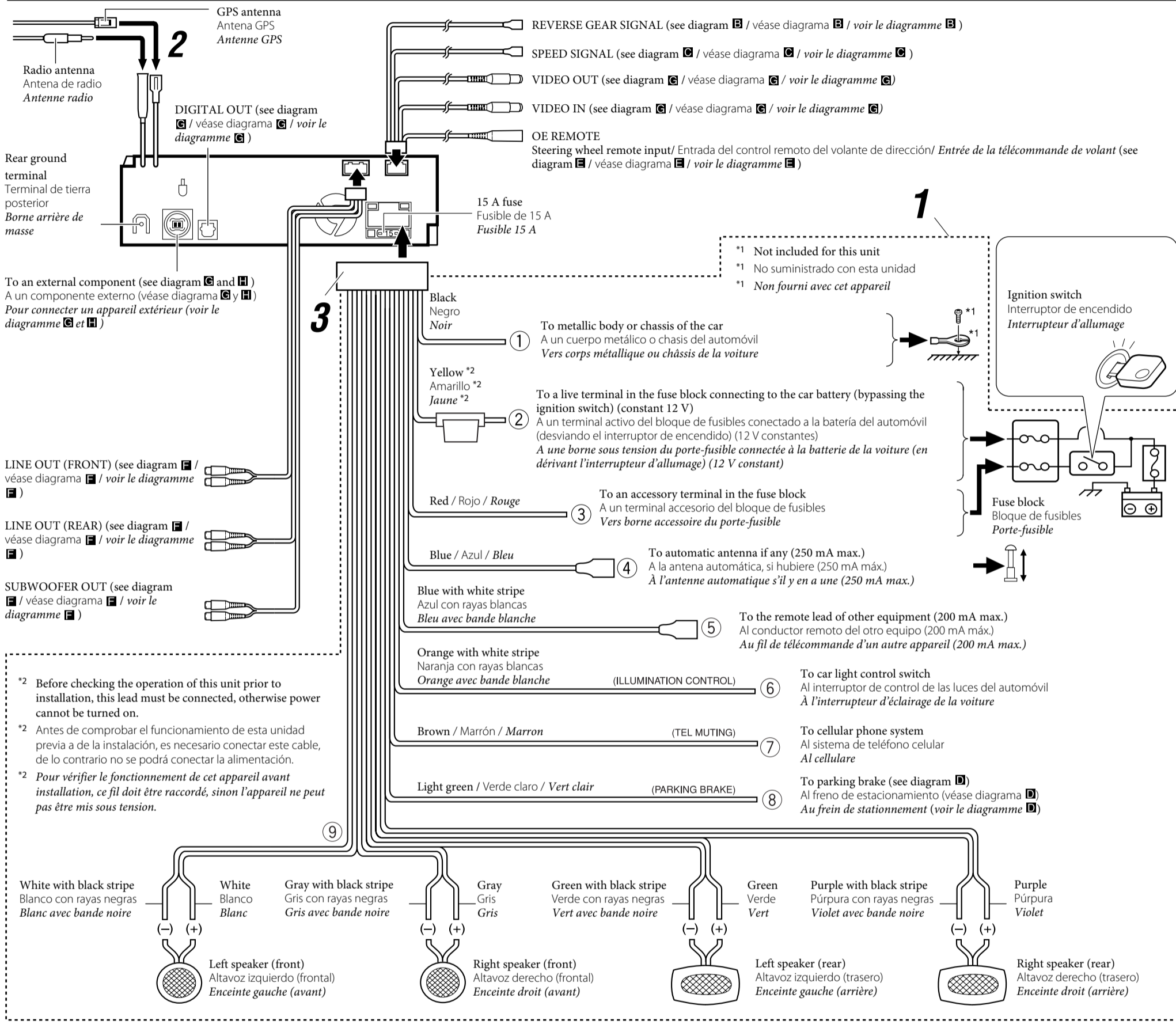

B Connecting the reverse gear signal lead / Conexión del cable de señal del engranaje de marcha atrás / Connexion du fil de signal de marche arrière

Locate the reverse lamp lead in the trunk.
Localice el conductor de la luz trasera en el compartimiento de equipajes.
Localisez le fil des feux de recul dans le coffre.

Reverse lamp lead
Conductor de la luz trasera
Fil des feux de recul

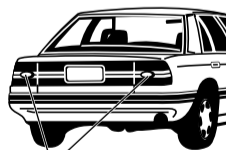
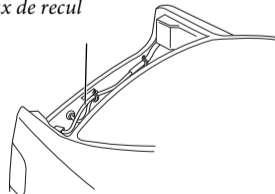

Reverse lamps
Luces traseras
Feux de recul

Purple with white stripe
Conductor de la luz trasera
Violet avec bande blanche

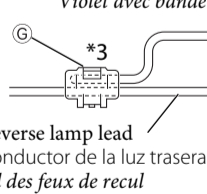

To reverse lamp
A la luz trasera
Aux feux de recul

To car battery
A la batería del automóvil
À la batterie de la voiture

KD-NXD505
REVERSE GEAR SIGNAL

C Connecting the speed signal lead / Conexión del cable de señal de velocidad / Connexion du fil de signal de vitesse

- This connection is necessary to use the Navigation System.
- Esta conexión es necesaria para poder usar el sistema de navegación.
- Cette connexion est nécessaire pour pouvoir utiliser le système de navigation.

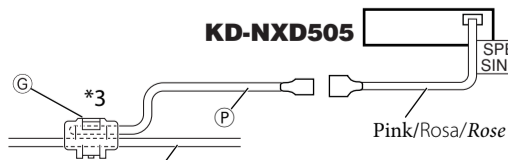

Signal lead from the speedometer
Conductor del velocímetro
Fil de signal de l'indicateur de vitesse

- If your car does not have a speed signal lead, use JVC's Speed Pulse Generator KV-PG1 (separately purchased).
- Si su coche no dispone de un conductor de la señal de velocidad, utilice el Generador de impulsos de velocidad KV-PG1 de JVC (vendido separadamente).
- Si votre voiture ne possède de pas de fil de signal de vitesse, utilisez le Générateur d'impulsions de vitesse KV-PG1 de JVC (vendu séparément).

***3 Connecting the crimp connector / Conexión del conector de presión / Connexion de la cosse sertie**

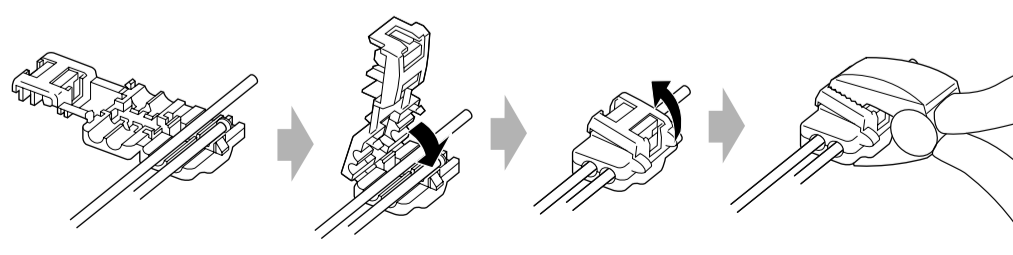

Contact the metallic part of the crimp to the wires inside.
Conecte la parte metálica del engarce a los cables interiores.
Mettez en contact la partie métallique de la cosse à sertir et des fils intérieurs.

Pinch the crimp firmly.
Apriete firmemente el engarce.
Pincez la cosse à sertir fermement.

D Connecting the parking brake lead / Conexión del cable del freno de estacionamiento / Connexion du cordon de frein de stationnement

Connect the parking brake lead to the parking brake system built in the car.
Conecte el cable del freno de estacionamiento al sistema de freno de estacionamiento del automóvil.
Connectez le fil de frein de stationnement au système de frein de stationnement.

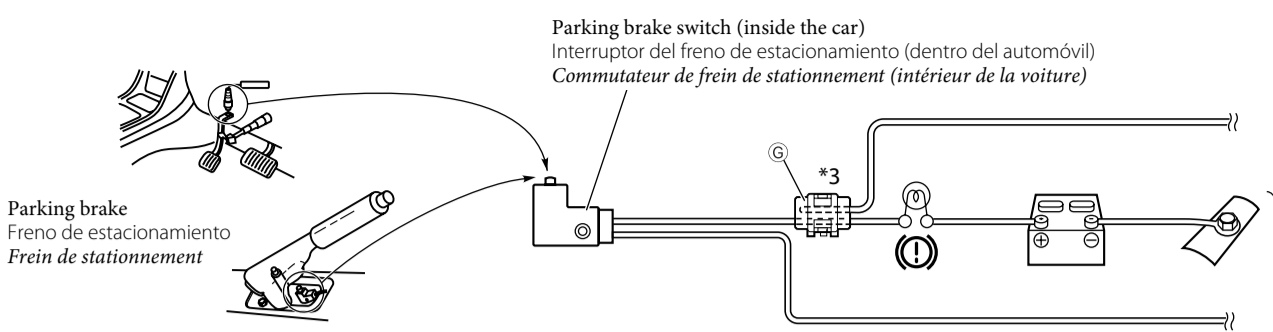

E Connecting to the steering wheel remote controller / Conexión al control remoto del volante de dirección / Connexion de la télécommande de volant

If your car is equipped with the steering wheel remote controller, you can operate this unit using the controller. For connection, an exclusive remote adapter (not supplied) which matches your car is required. For details, consult the same car audio dealer as where the unit is purchased.
Si su vehículo está equipado con control remoto en el volante de dirección, podrá hacer funcionar este receptor utilizando dicho control. Para la conexión, se requiere un adaptador remoto exclusivo (no suministrado) que sea adecuado para su automóvil. Para los detalles, consulte con el concesionario car audio donde compró el receptor.
Si votre voiture est munie d'une télécommande de volant, vous pouvez commander cet autoradio en utilisant la télécommande. Pour la connexion, un adaptateur de télécommande exclusif (non fourni) correspondant à votre voiture est requis. Pour en savoir plus, consultez le revendeur autoradio auprès duquel vous avez acheté cet autoradio.

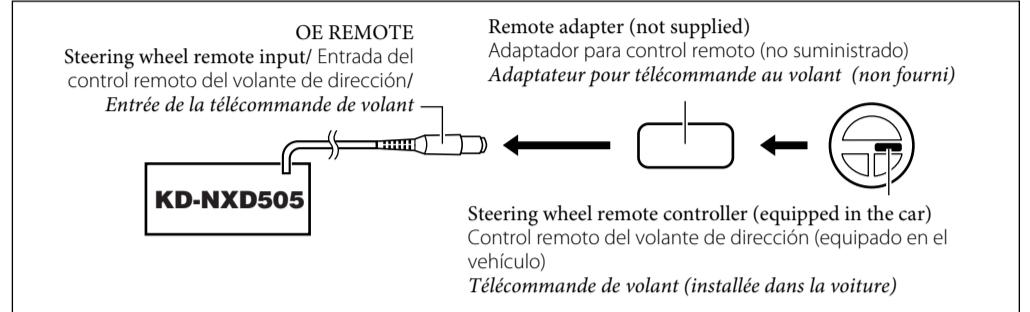

F Connecting the external amplifiers / Conexión a los amplificadores externos / Connexion d'amplificateurs extérieurs

You can connect amplifiers to upgrade your car stereo system.

- Connect the remote lead (blue with white stripe) to the remote lead of the other equipment so that it can be controlled through this unit.
- Disconnect the speakers from this unit, and connect them to the amplifier. Leave the speaker leads of this unit unused.
- You can switch off the built-in amplifier and send the audio signals only to the external amplifier(s) to get clear sounds and to prevent internal heat built-up inside the unit. See page 95 of the INSTRUCTIONS (separate volume).
- Guidance voice comes out only through the front speakers (and the front line out on the rear).

Usted podrá conectar amplificadores para mejorar el sistema estéreo de su automóvil.

- Conecte el conductor remoto (azul con rayas blancas) al conductor remoto del otro equipo para poderlo controlar a través de esta unidad.
- Desconecte los altavoces de esta unidad y conéctelos al amplificador. Los cables de los altavoces de esta unidad quedan sin usar.
- Podrá desconectar el amplificador incorporado y enviar las señales de audio solamente al(los) amplificador(es) externo(s) para obtener sonidos nítidos y evitar que se caliente el interior de la unidad. Véase la página 95 de las MANUAL DE INSTRUCCIONES (volumen separado).
- La guía de voz se escucha sólo a través de los altavoces delanteros (y la salida de línea delantera en la parte trasera).

Vous pouvez connecter des amplificateurs pour améliorer votre système autoradio.

- Connectez le fil de commande à distance (bleu avec bande blanche) au fil de commande à distance de l'autre appareil de façon qu'il puisse être commandé via cet appareil.
- Déconnectez les enceintes de cet appareil et connectez-les à l'amplificateur. Laissez les fils d'enceintes de cet appareil inutilisés.
- Vous pouvez désactiver l'amplificateur intégré et envoyer les signaux audio uniquement à un ou plusieurs amplificateurs extérieurs afin d'obtenir un son clair et pour éviter un échauffement interne de l'appareil. Référez-vous à la page 95 du MANUEL D'INSTRUCTIONS (volume séparé).
- La voix de guidage sort uniquement par les enceintes avant (et la sortie de ligne à l'arrière).

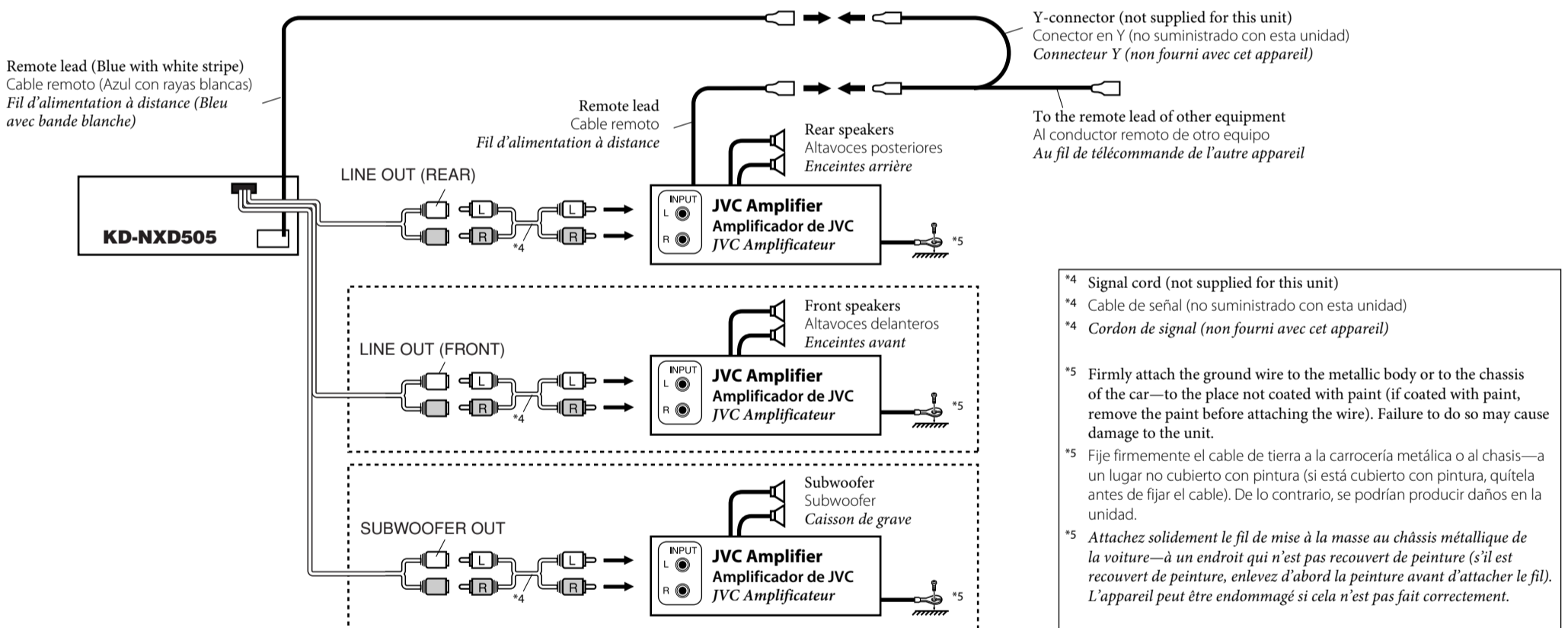

G Connections for external component playback / Conexiones para la reproducción del componente externo / Connexions pour un appareil de lecture extérieur

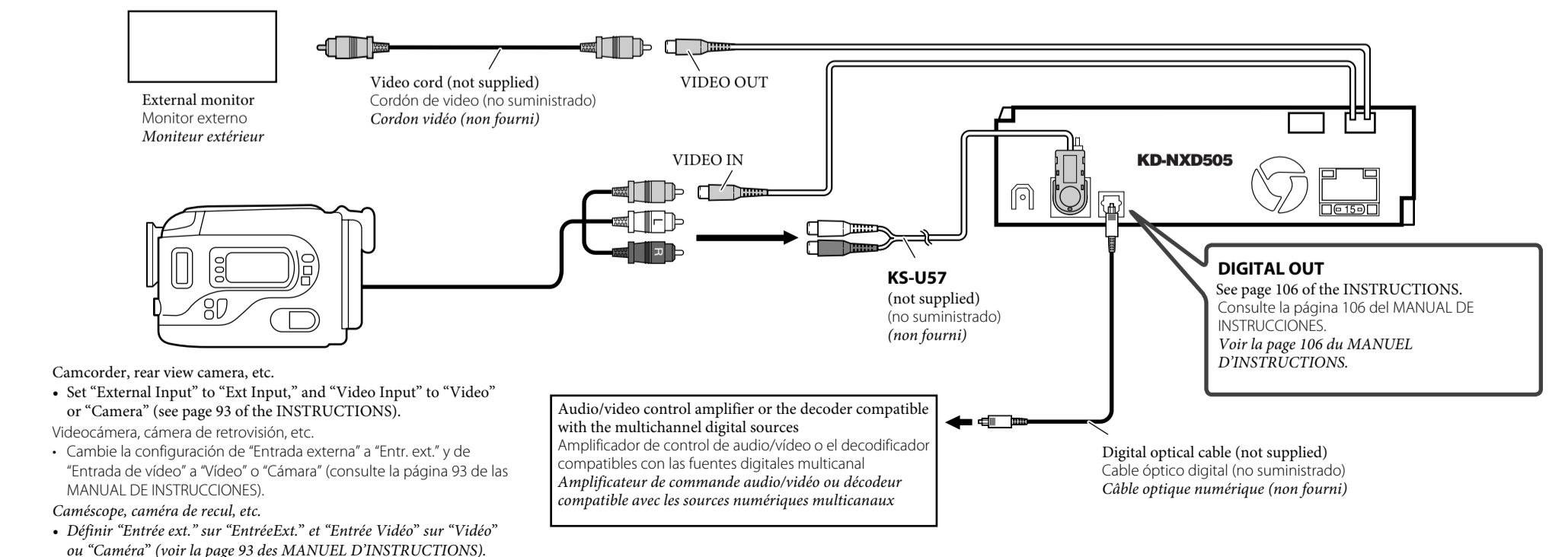

H Connecting other external components / Conexión de otros componentes externos / Connexion d'un autre appareil extérieur

You can connect external components in series as shown in the diagram below.

- All the components, adapters or signal cords need to be purchased separately.

CAUTION:

Before connecting the external components, make sure that the unit is turned off.

- To use JVC CD changer, Apple iPod or JVC D. player, set "External Input" to "Changer" (see page 93 of the INSTRUCTIONS).
- To use other external components via KS-U57, KS-U58, or KS-U100K, set "External Input" to "Ext Input" (see page 93 of the INSTRUCTIONS).

Los componentes externos se pueden conectar en serie, tal como se muestra en el diagrama siguiente.

- Todos los componentes, adaptadores o cables de señal se deben comprar separadamente.

PRECAUCION:

Antes de conectar el cambiador de componentes externos, asegúrese de que el receptor esté apagado.

- Para utilizar un cambiador de CD JVC, Apple iPod o reproductor D. de JVC, ajuste "Entrada externa" a "Cambiador" (véase la página 93 del MANUAL DE INSTRUCCIONES).
- Para utilizar otros componentes externos a través de KS-U57, KS-U58 o KS-U100K, ajuste "Entrada externa" a "Entr. ext." (véase la página 93 del MANUAL DE INSTRUCCIONES).

Vous pouvez connecter des appareils extérieurs en série comme montré sur l'illustration ci-dessous.

- Tous les composants, adaptateurs ou cordons de signal doivent être achetés séparément.

PRECAUTION:

Avant de connecter votre appareil extérieur, assurez-vous que l'autoradio est hors tension.

- Pour utiliser un changeur de CD JVC, un iPod Apple ou le lecteur D. de JVC, réglez "Entrée ext." sur "Changeur" (voir page 93 du MANUEL D'INSTRUCTION).
- Pour utiliser d'autres appareils extérieurs via le KS-U57, KS-U58 ou KS-U100K, réglez "Entrée ext." sur "EntréeExt." (voir page 93 du MANUEL D'INSTRUCTION).

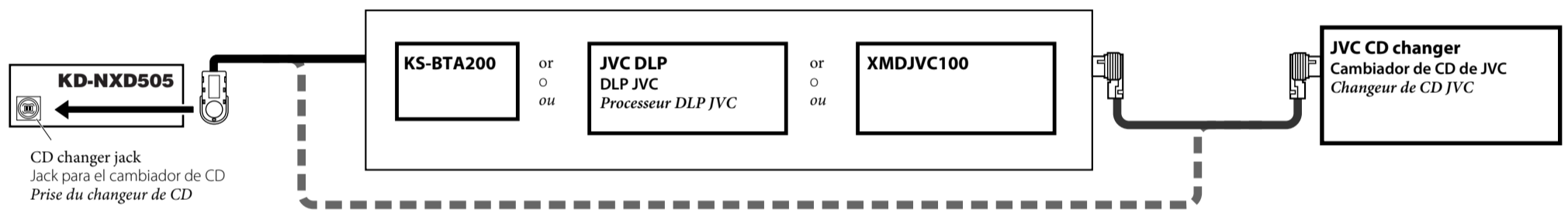
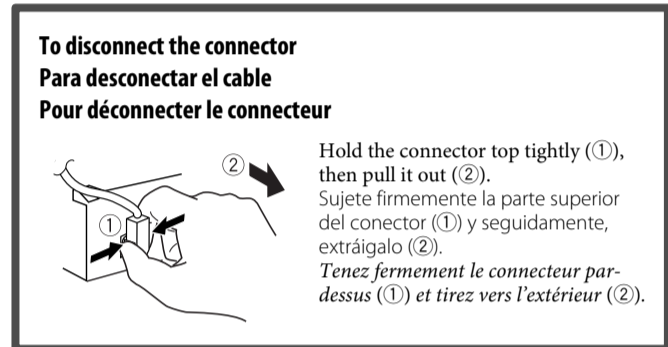
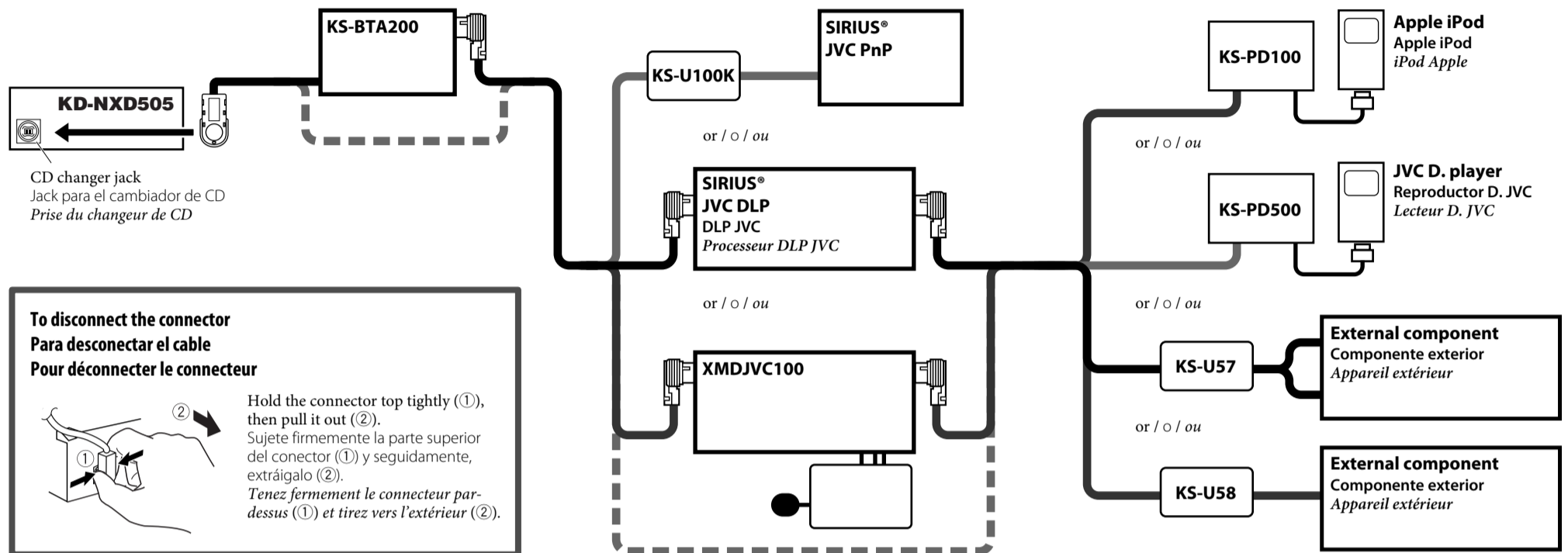

iPod is a trademark of Apple Inc., registered in the U.S. and other countries.
iPod es una marca comercial de Apple Inc., registrada en los EE.UU. y otros países.
iPod est une marque de commerce d'Apple Inc., enregistrée aux États-Unis et dans les autres pays.

XM Satellite radio / radio satelital XM / radio satellite XM

- For listening to the XM Satellite radio, connect XMDirect™ Universal Tuner Box (separately purchased) to this unit using JVC Smart Digital Adapter—XMDJVC100 (not supplied).
- Para escuchar la radio satelital XM, también puede conectar el Sintonizador universal XMDirect™ (adquirido por separado) al receptor mediante un adaptador Smart Digital XMDJVC100 de JVC (no suministrado).
- Pour écouter la radio satellite XM, vous pouvez aussi connecter le tuner universel XMDirect™ (vendu séparément) à cet appareil en utilisant l'adaptateur numérique intelligent JVC—XMDJVC100 (non fourni).

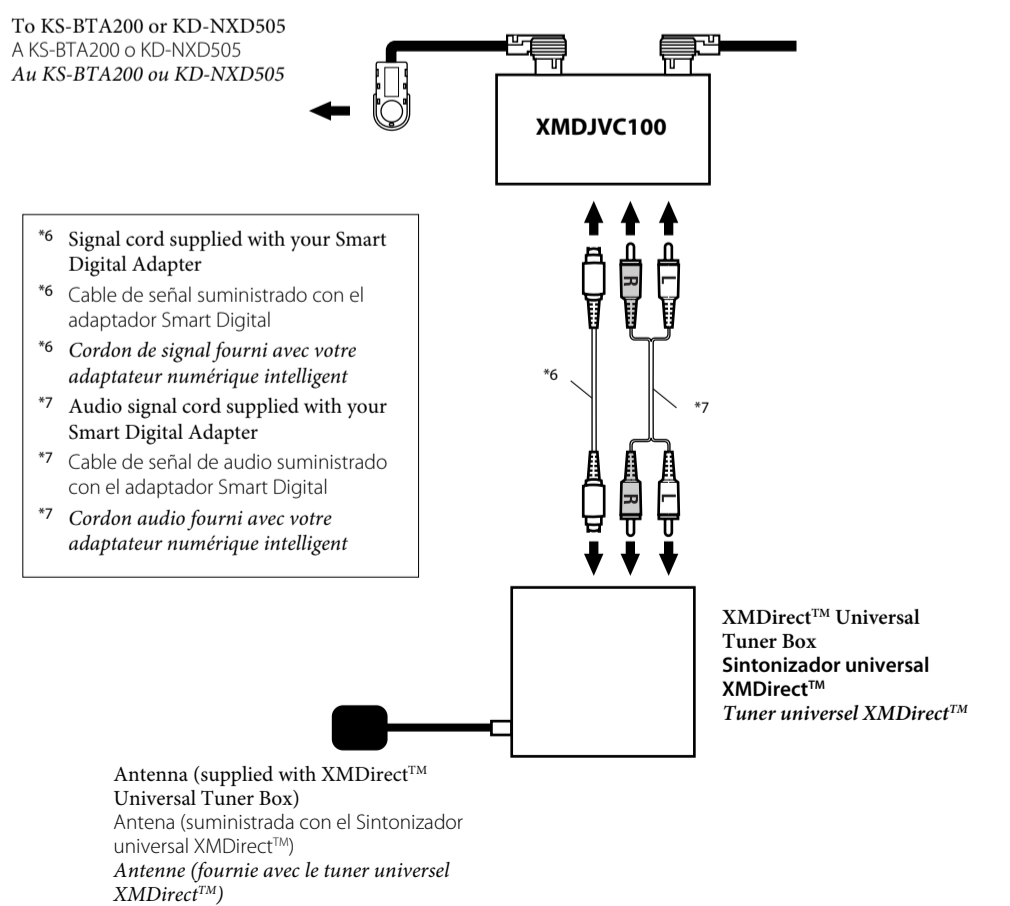

JVC PnP (Plug and Play) / PnP ("Plug and Play") JVC / PnP ("Plug and Play") JVC

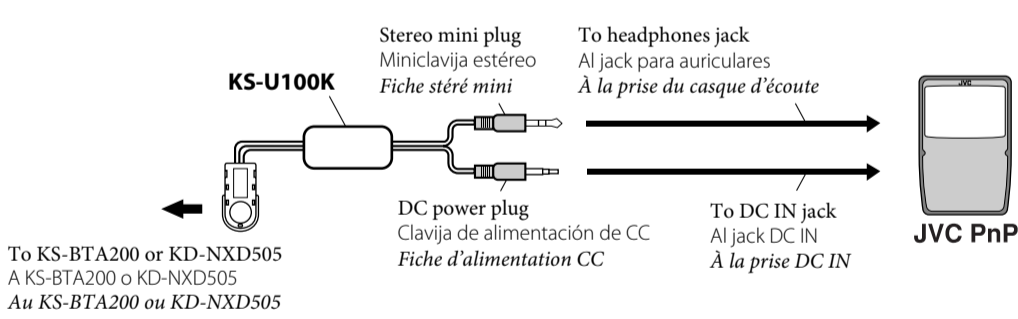

External component / Componente exterior / Appareil extérieur

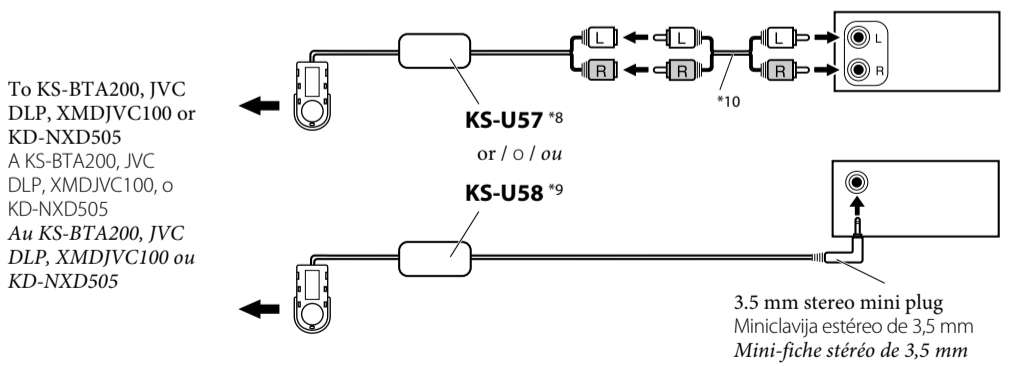

- *8 Line Input Adapter KS-U57 (separately purchased)
- *8 Adaptador de entrada de línea KS-U57 (adquirido opcionalmente)
- *8 Adaptateur pour entrée de ligne KS-U57 (vendu séparément)
- *9 Aux Input Adapter KS-U58 (separately purchased)
- *9 Adaptador de entrada auxiliar KS-U58 (adquirido opcionalmente)
- *9 Adaptateur pour entrée auxiliaire KS-U58 (vendu séparément)
- *10 Signal cord (not supplied)
- *10 Cable de señal (no suministrado)
- *10 Cordon de signal (non fourni)